

# Alfa til Ómega

Íslenskir stafir, myndir og orð ásamt verkefnum.  
Línurnar eru til að kennarinn geti sjálfur gefið forskrift.

---

i l oO æÆ

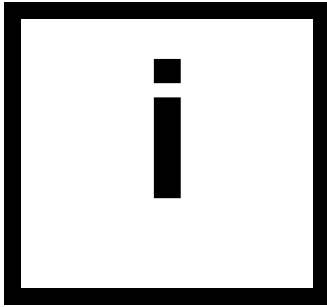

i



indíáni

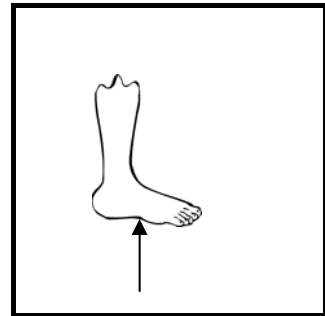

il

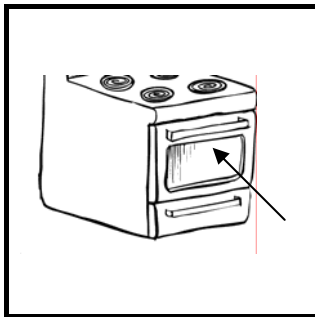

ofn

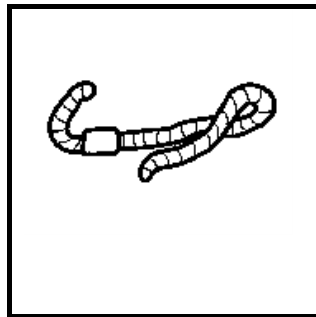

ormur

OKTÓBER						
má	þri	mi	fi	fö	la	su
			1	2	3	4
5	6	7	8	9	10	11
12	13	14	15	16	17	18
19	20	21	22	23	24	25
26	27	28	29	30	31	

október

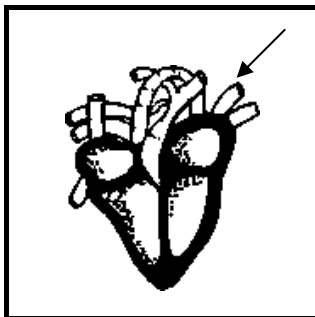

æð



æpa



æla

Handwriting practice lines consisting of four sets of horizontal lines: a solid top line, a dashed middle line, and a solid bottom line.

a A    yY    öÖ

---

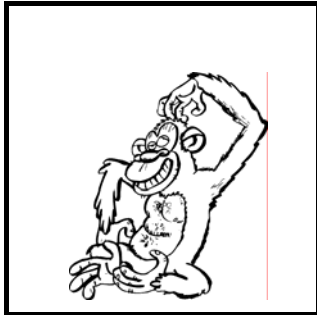

api

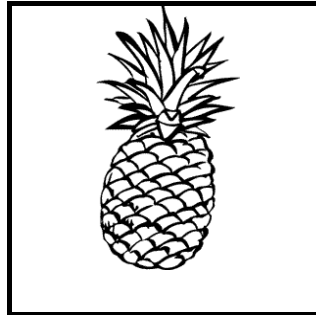

ananas

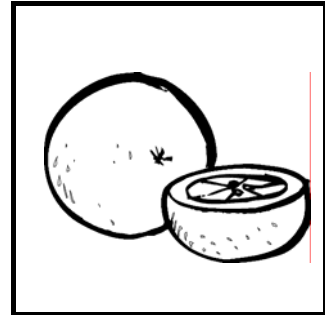

appelsína

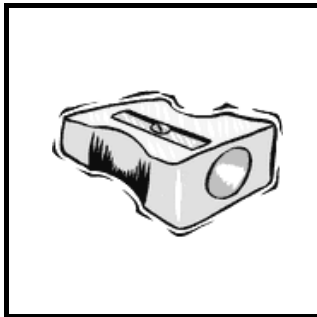

yddari

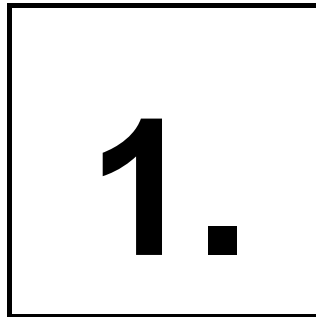

fyrstur

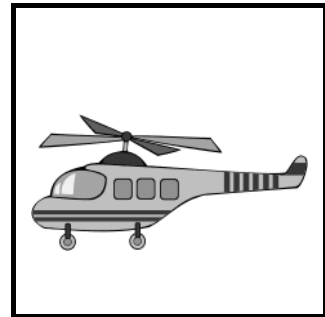

þyrlla

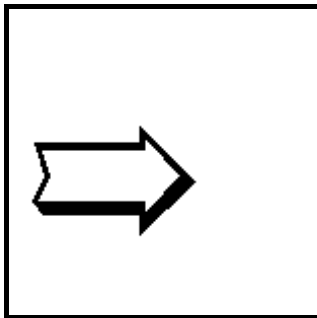

ör

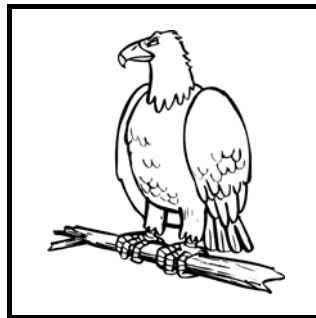

örn

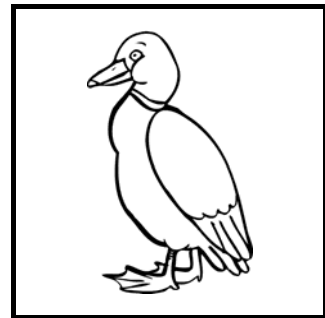

önd

---

---

---

---

---

---

---

---

---

---

**uU eE au Au**

---



**ugla**

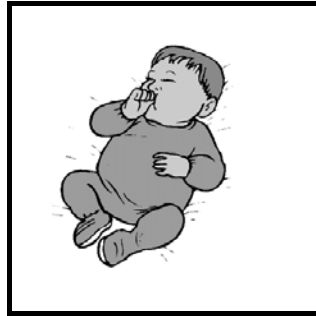

**ungbarn**

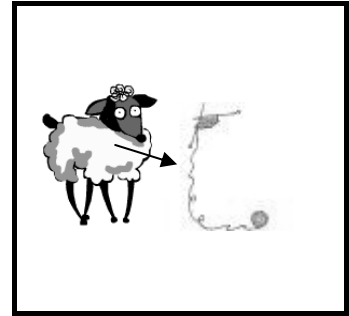

**ull**

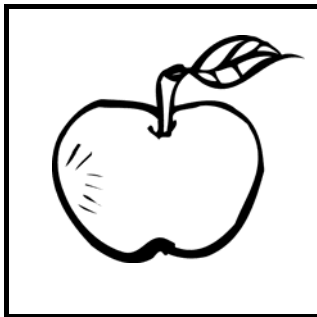

**epli**



**eðla**

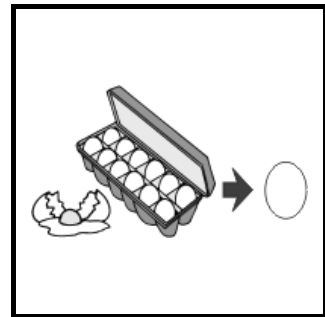

**egg**

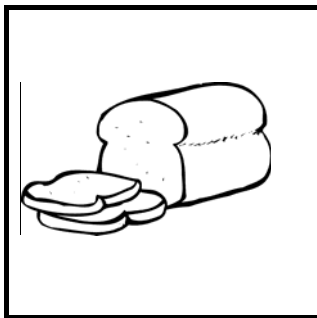

**brauð**



**ausa**

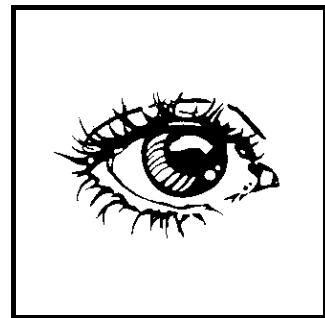

**auga**

---

---

---

---

---

---

---

---

---

---

# Í Í ÚÚ ÓÓ

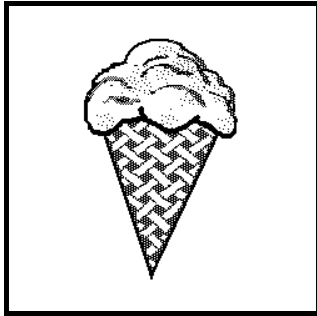

Ís

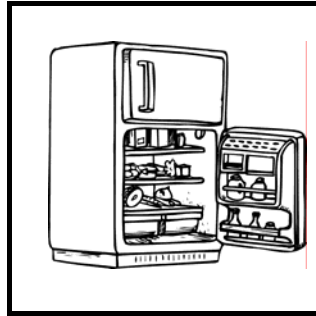

Ísskápur

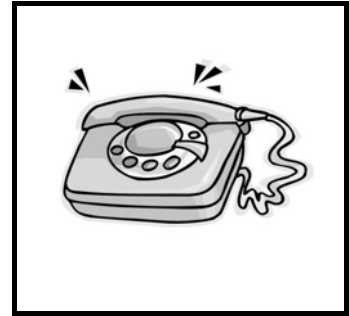

Sími



Úr

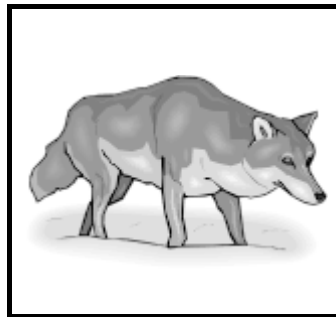

Úlfur

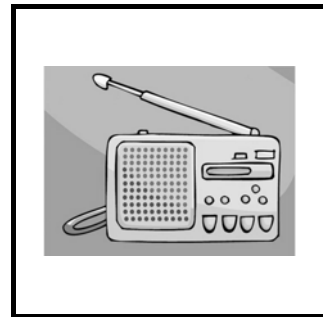

Útvarp



Óbó

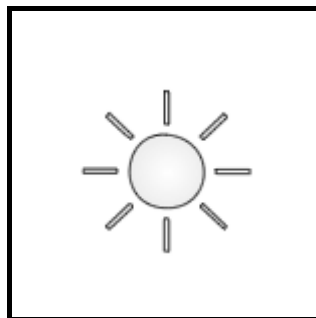

Sól

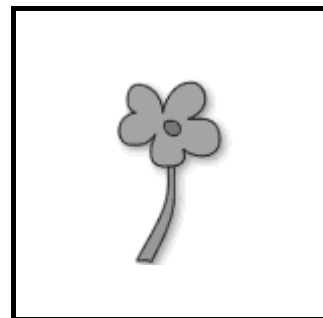

Blóm

-----  
-----  
-----  
-----  
-----  
-----  
-----  
-----

**yÝ áÁ éÉ**

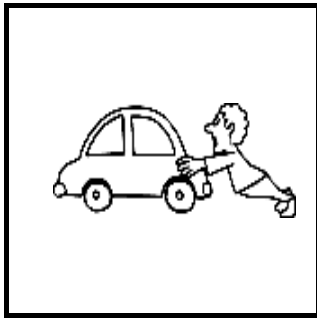

**yíta**



**sundskýla**

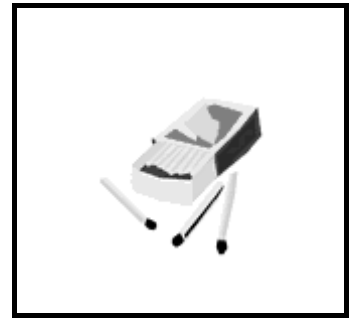

**eldspýtur**

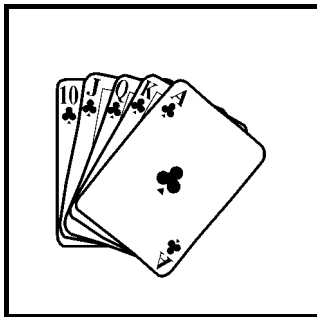

**ás**

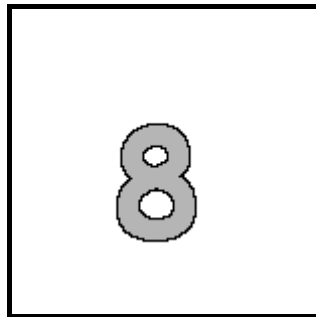

**átta**

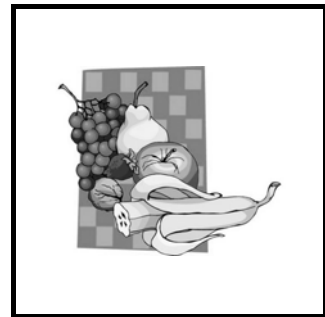

**ávextir**

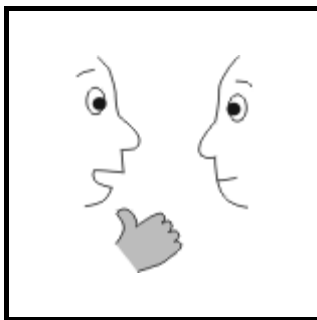

**ég**



**él**

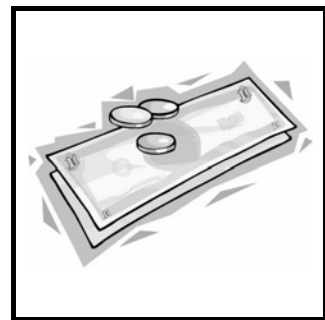

**fé**

-----  
-----  
-----  
-----  
-----  
-----  
-----

# eiEI eyEY ðÐ

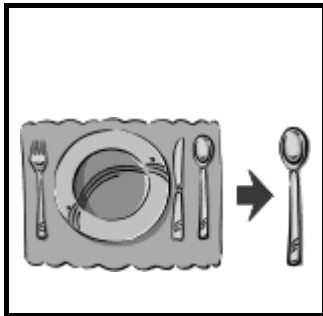

skeið



reiður

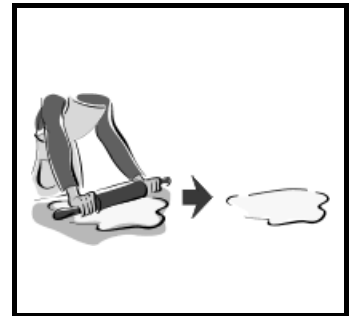

deig



eyra

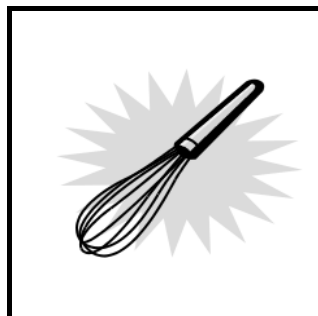

þeytari



keyra

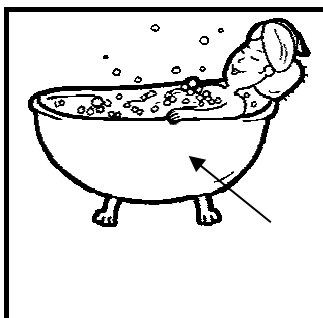

bað



fjöður



jarðarber

-----  
-----  
-----  
-----  
-----  
-----  
-----

# þ Þ



þvottavél



þurrkari



þyrla

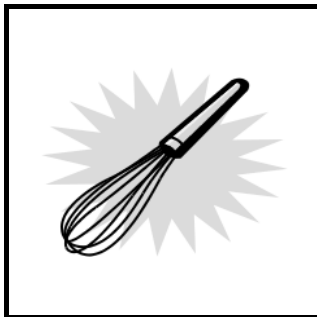

þeytari

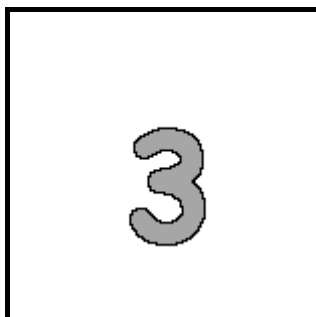

þrír



þjónn

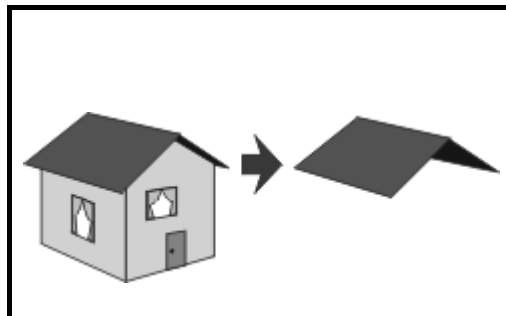

þak

-----  
-----  
-----  
-----  
-----  
-----  
-----  
-----



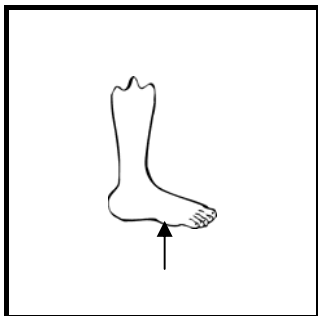

-----  
-----  
-----  
-----  
-----

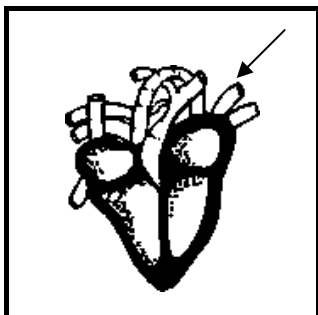

-----  
-----  
-----  
-----  
-----

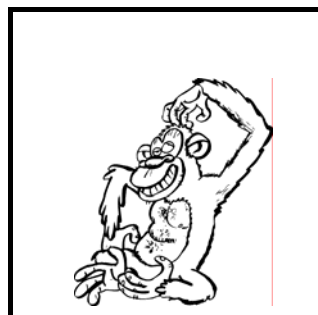

-----  
-----  
-----  
-----  
-----

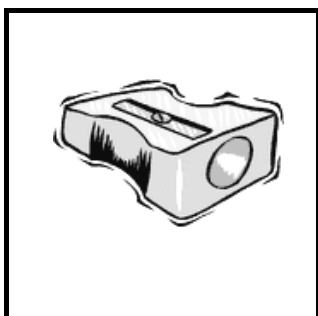

-----  
-----  
-----  
-----  
-----

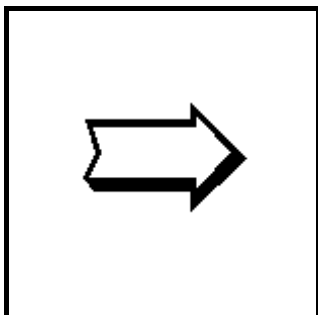

-----  
-----  
-----  
-----  
-----

Petta er uglá  
Petta er úlfur

Petta er egg  
Petta er epli

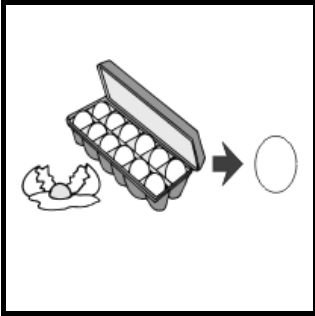
Petta er eyra  
Petta er auga

Petta er fé  
Petta er ís

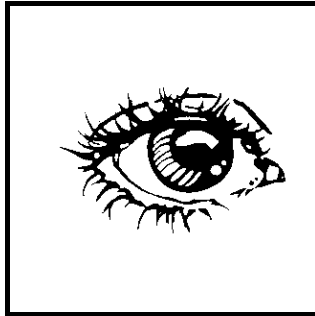
Petta er ég  
Petta er úr

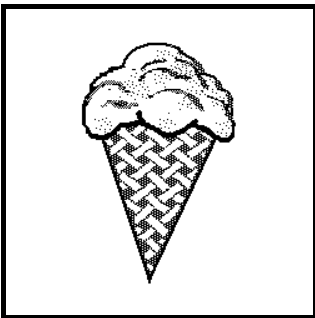
**b i e æ a y ö u o au**

**B**



bindi



ber

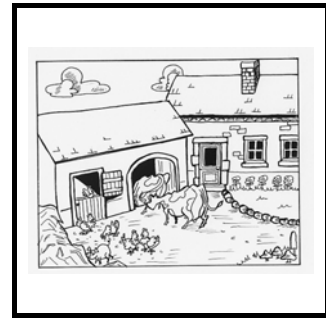

bær



barn

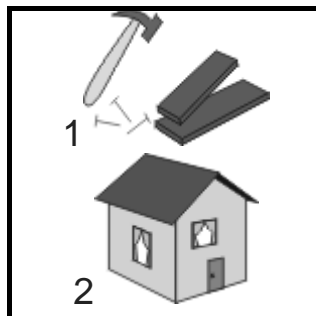

byggja

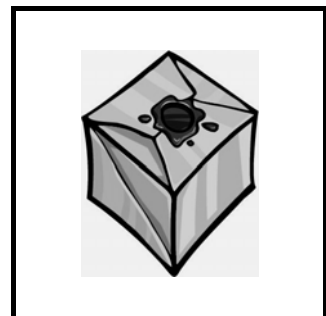

böggull



bursti

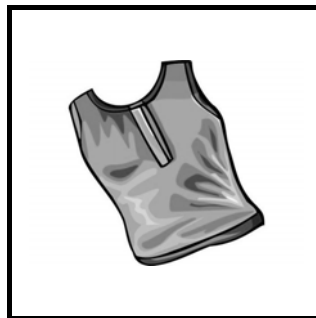

bolur



baunir

-----  
-----  
-----  
-----  
-----  
-----  
-----  
-----

**f i e æ a y ö u o ey F**

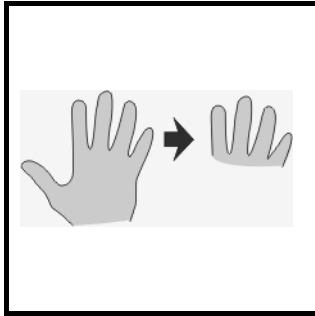

fingur

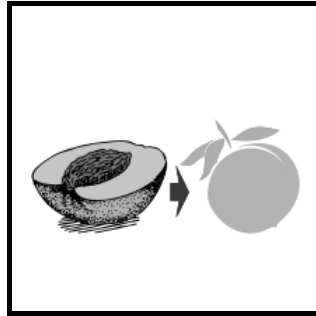

ferskja

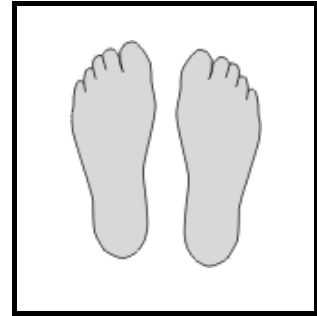

fætur



faðma

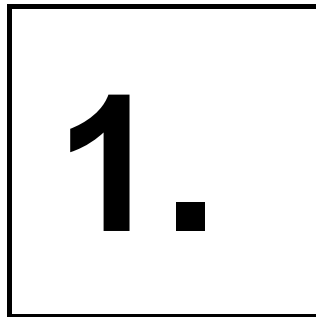

fyrsti

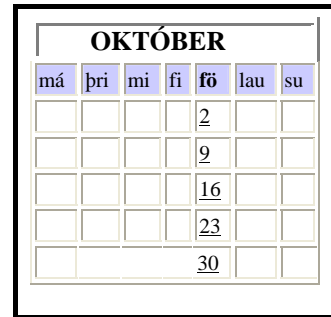

föstudagur

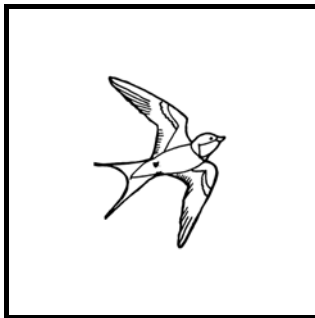

fugl

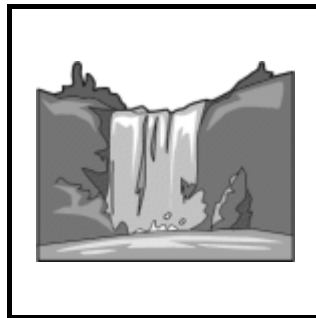

foss

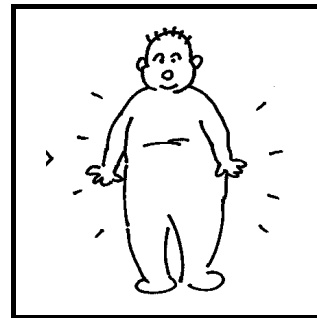

feitur

-----  
-----  
-----  
-----  
-----  
-----  
-----  
-----

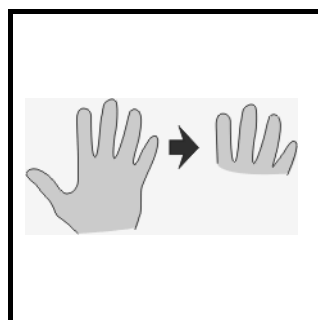
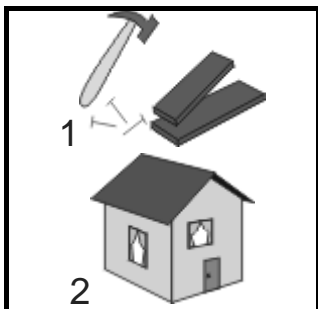

1.



Handwriting practice lines consisting of a solid top line, a dashed middle line, and a solid bottom line. There are 10 sets of these lines, one set corresponding to each illustration on the left.



- Petta er banani
- Petta er bær

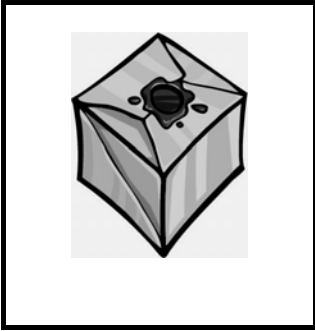

- Petta er böggull
- Petta er ferskja

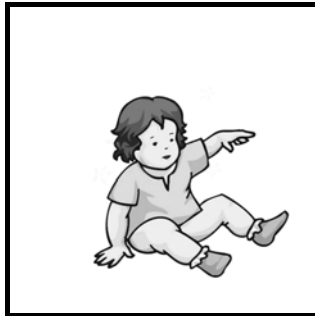

- Petta er bolur
- Petta er barn

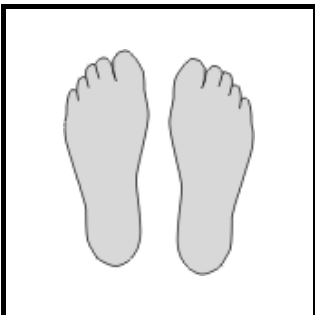

- Petta eru fætur
- Petta eru fingur

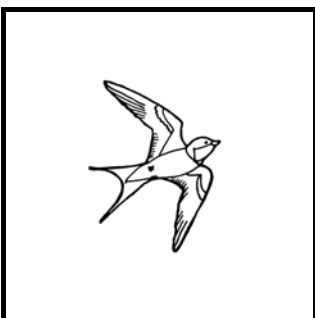

- Petta er bolur
- Petta er fugl

**d i e æ a y ö u o ei D**

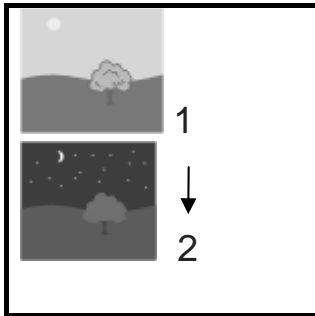

dimma

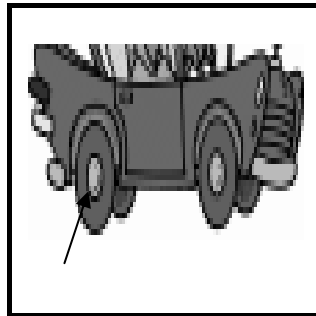

dekk

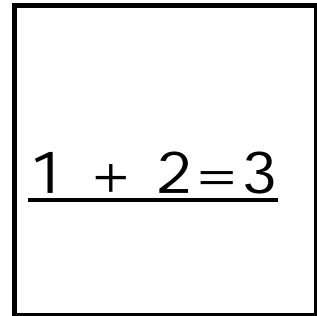

dæmi

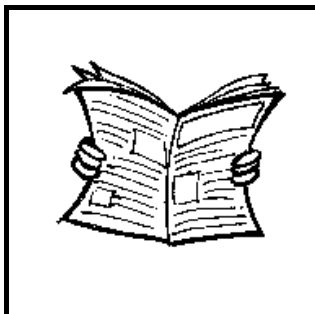

dagblað

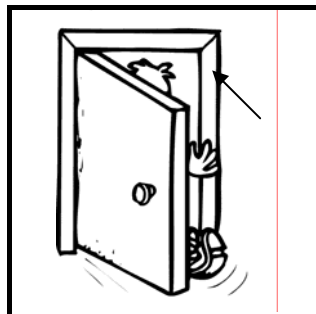

dyr



döðlur



dumbungur

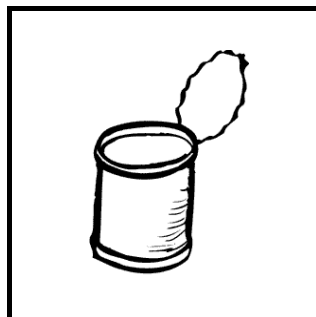

dolla



dauðpreytt

.....

.....

.....

.....

.....

.....

.....

**g i e æ a y ö u o ei**

**G**

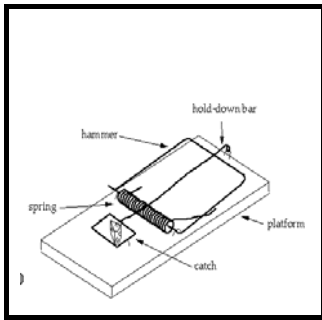

gildra

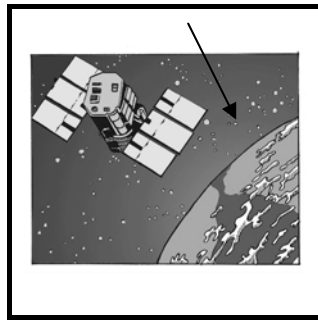

geimur

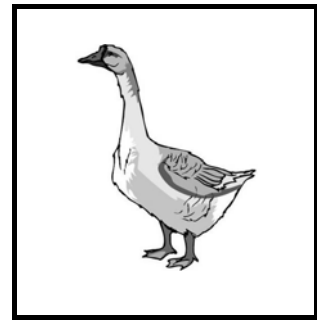

gæs

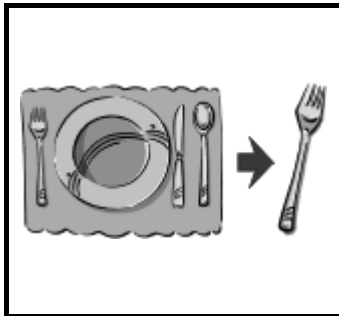

gaffall

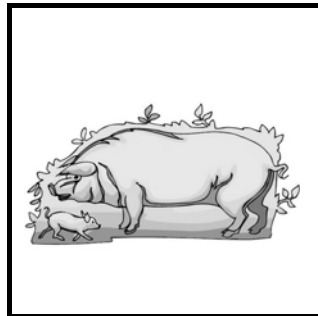

gylta

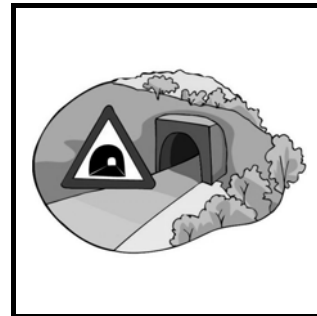

göng



gulrót

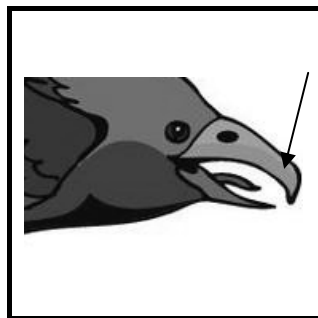

goggur

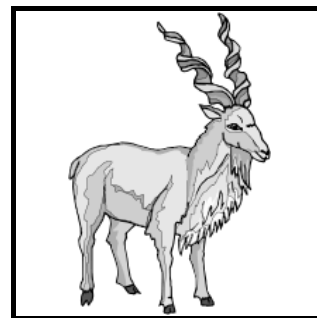

geit

-----  
-----  
-----  
-----  
-----  
-----  
-----  
-----



**h i e æ a y ö u o au H**

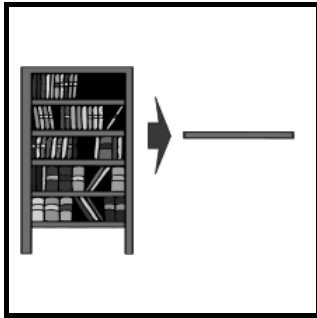

hilla

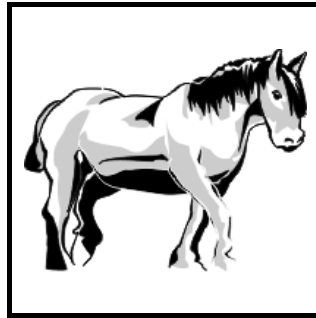

hestur

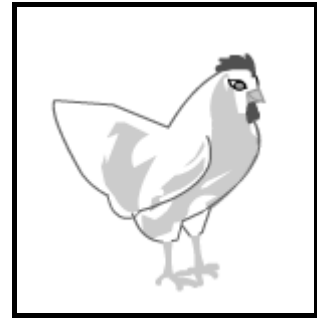

hæna



hattur

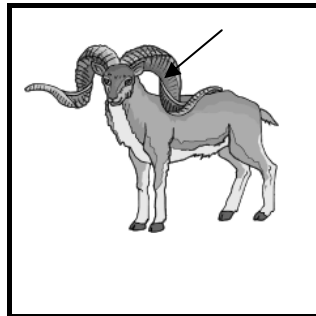

hyrndur

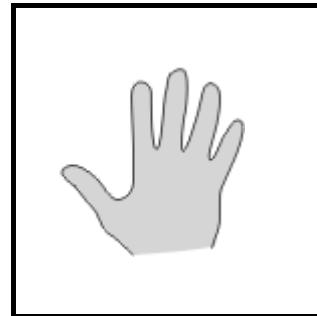

hönd

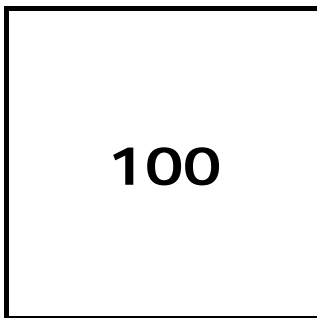

hundrað

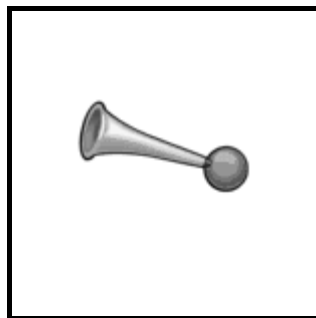

horn

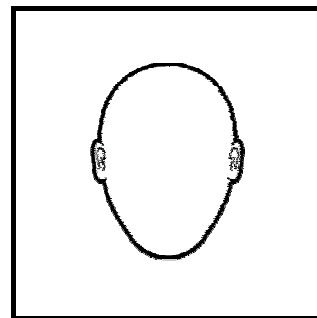

haus

-----  
-----  
-----  
-----  
-----  
-----  
-----  
-----

$$1 + 2 = 3$$



100

A series of horizontal lines for writing, consisting of a solid top line, a dashed middle line, and a solid bottom line. There are 20 such sets of lines, one for each row of content on the page.

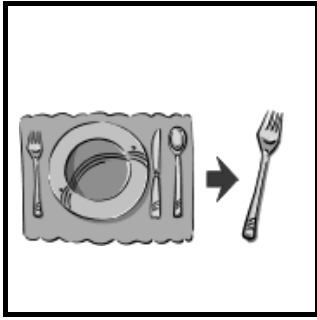

- Petta er hilla
- Petta er gaffall

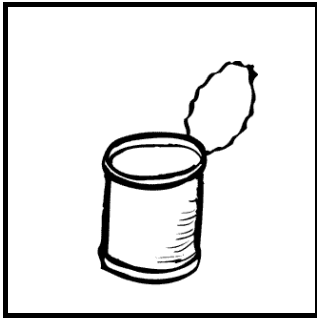

- Petta er dolla
- Petta er hattur



- Petta er gæs
- Petta er gulrót

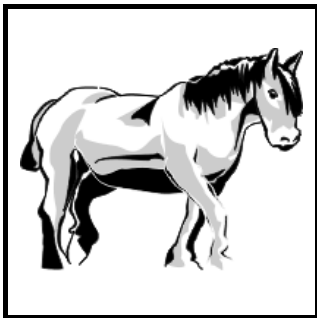

- Petta er hattur
- Petta er hestur

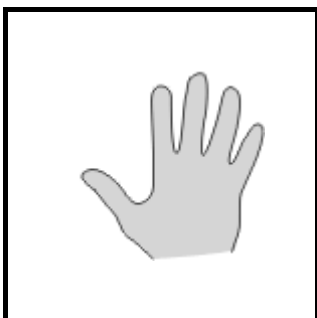

- Petta er hönd
- Petta er horn

**j k i e æ a y ö u o**

**J K**



kind

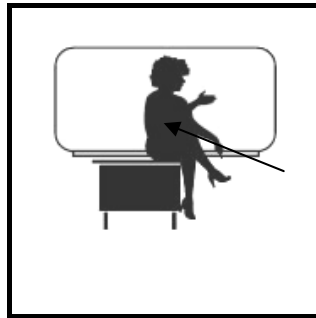

kennari

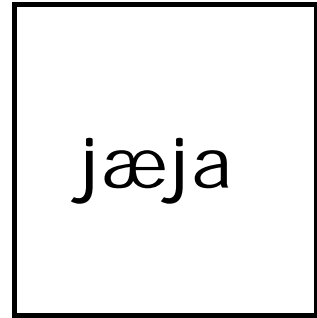

jæja

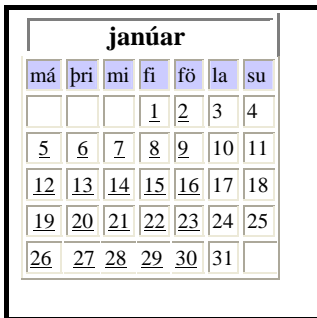

janúar

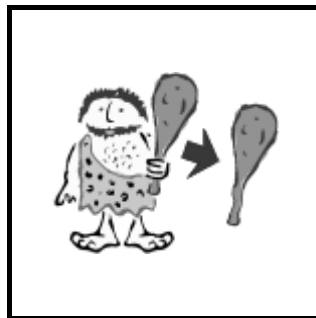

kylfa

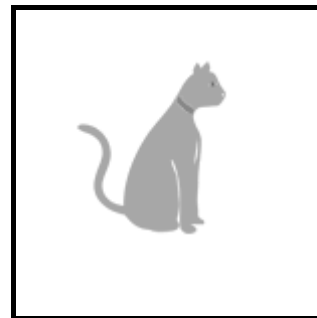

köttur



jurt

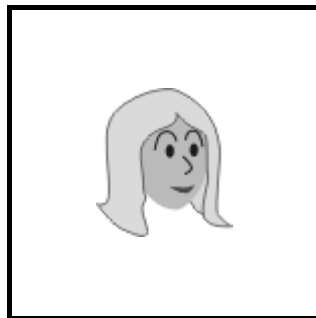

kona

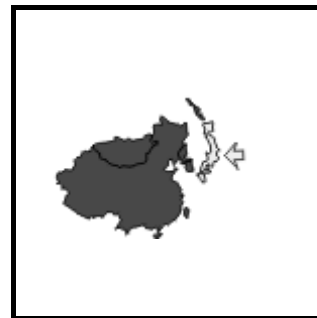

Japan

-----  
-----  
-----  
-----  
-----  
-----  
-----  
-----

jæja

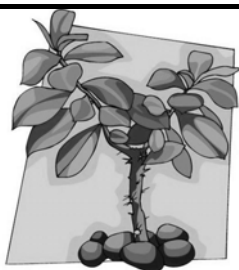

Handwriting practice lines consisting of a solid top line, a dashed middle line, and a solid bottom line. There are 20 such sets of lines, one for each row of the page.



Þetta er kind

Þetta er kylfa



Þetta er Japan

Þetta er köttur



Þetta er jurt

Þetta er janúar

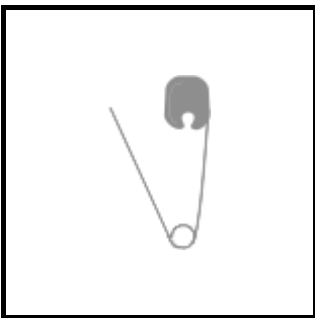

Þetta er pera

Þetta er næla

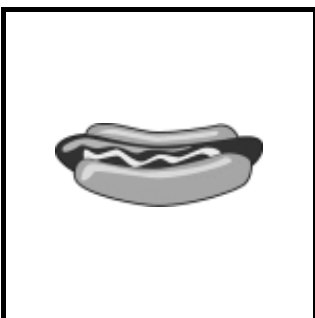

Þetta er pylsa

Þetta er poki

**l i e æ a y ö u o au L**

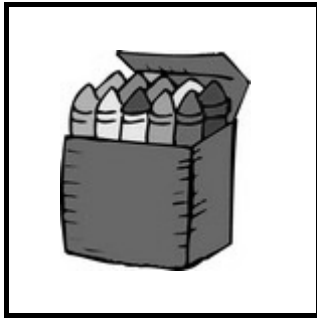

litir

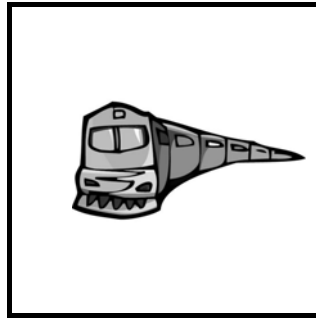

lest



læri

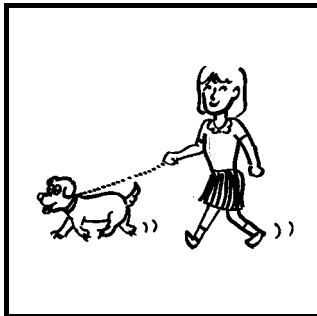

labba



lykill



lögregla

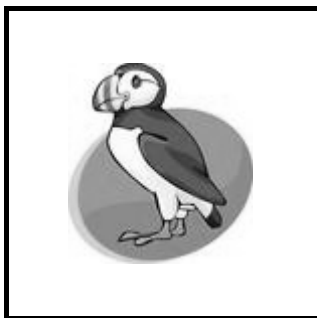

lundi

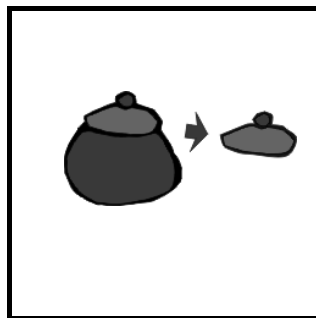

lok

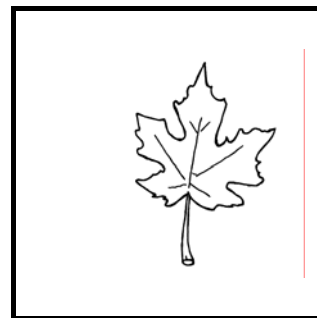

lauf

Handwriting practice lines consisting of three sets of horizontal lines (top, middle dashed, bottom) for writing practice.

**m**                    **i e æ a y ö u o au**                    **M**

---

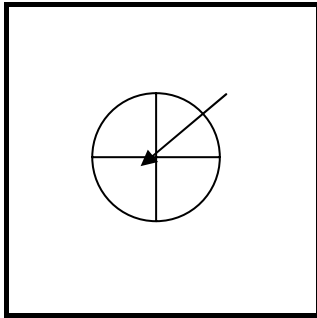

miðja

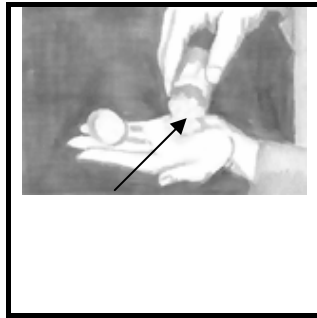

meðal

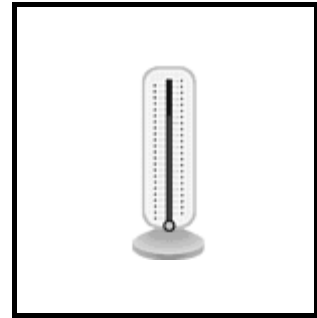

mælir

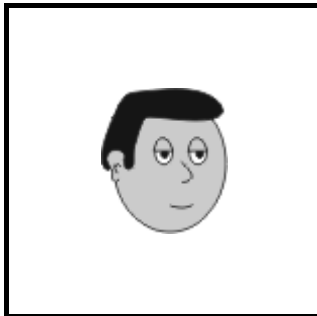

maður

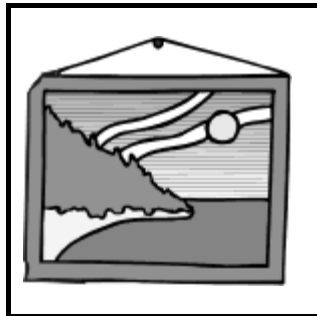

mynd

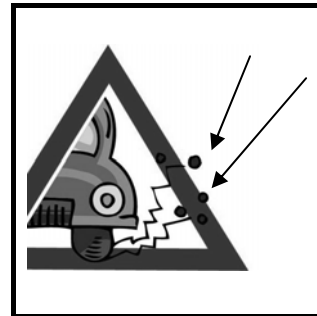

möl

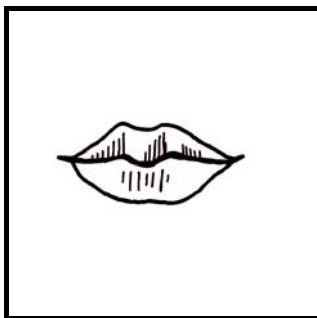

munnur

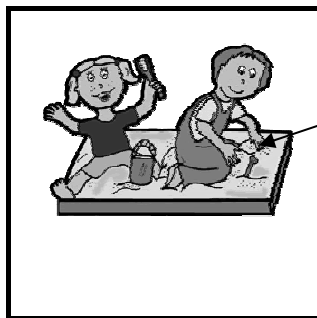

moka

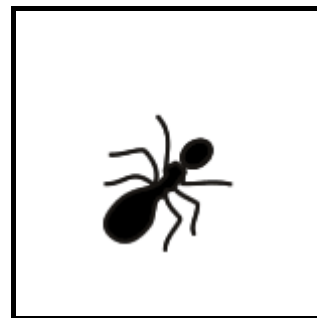

maur

---

---

---

---

---

---

---

---

---

---





-----  
-----  
-----  
-----  
-----

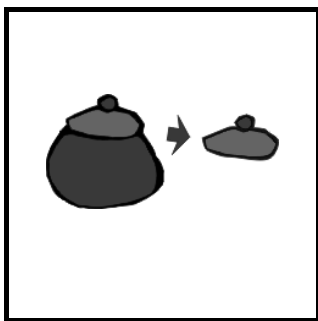

-----  
-----  
-----  
-----  
-----

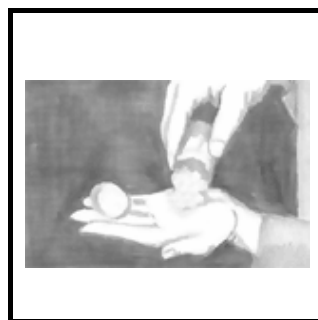

-----  
-----  
-----  
-----  
-----

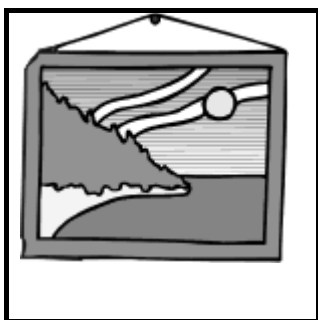

-----  
-----  
-----  
-----  
-----

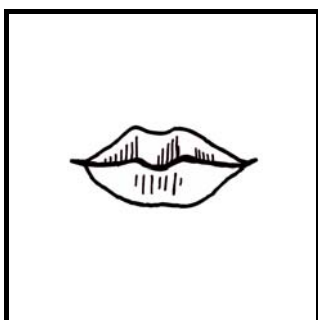

-----  
-----  
-----  
-----  
-----

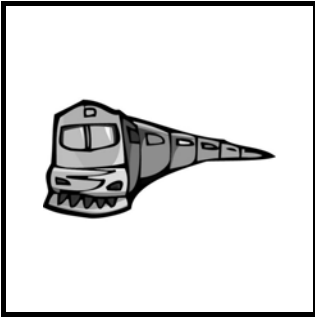

- Petta eru litir
- Petta er lest



- Petta er lykill
- Petta er lok

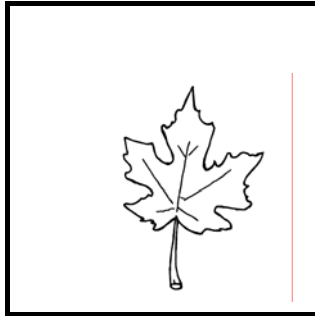

- Petta er lauf
- Petta er lögregla

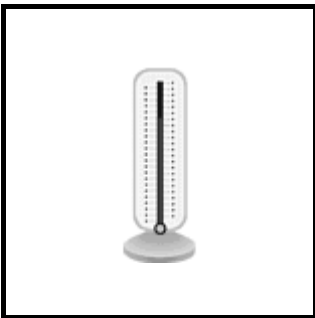

- Petta er miðja
- Petta er mælir

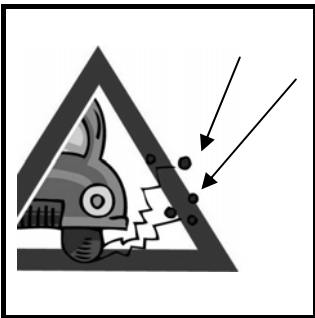

- Petta er maur
- Petta er möl

n p i e æ a y ö u o ei NP

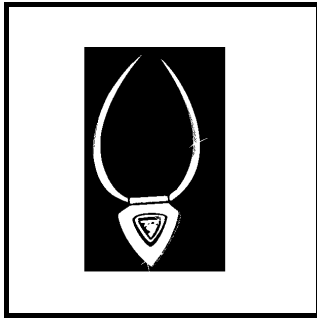

nisti

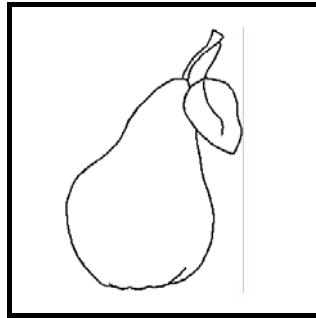

pera

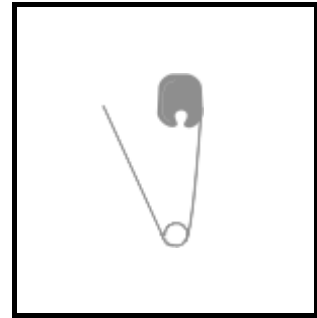

næla

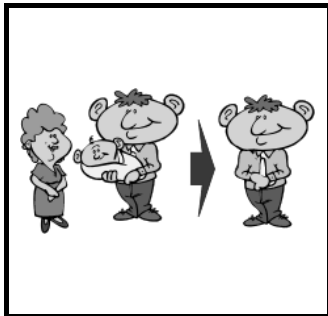

pabbi

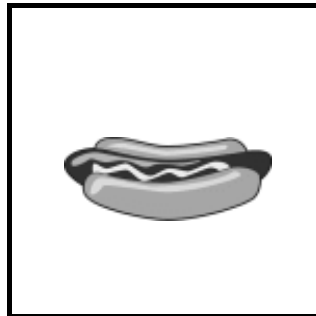

pylsa

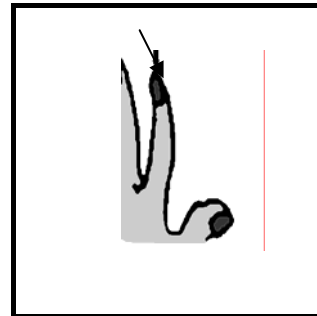

nögl



nunna

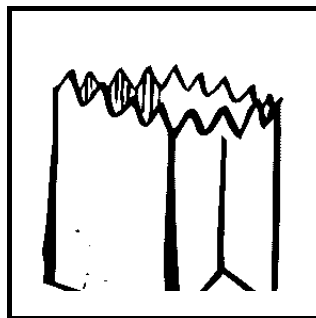

poki

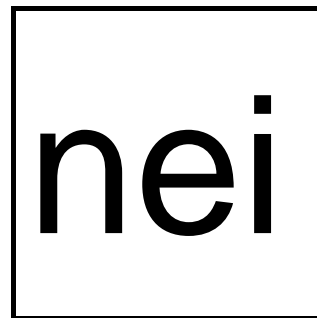

nei

Handwriting practice lines consisting of four sets of three horizontal lines (top, middle, bottom) with a dashed line in the middle.

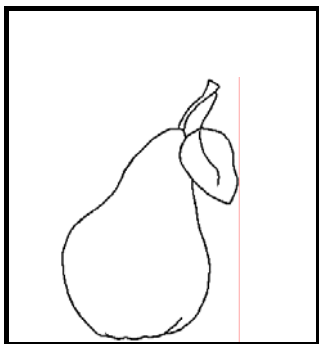

Handwriting practice lines for the letter 'n'. The first set consists of a solid top line, a dashed middle line, and a solid bottom line. The second set consists of a solid top line and a solid bottom line.

Handwriting practice lines for the letter 'n'. The first set consists of a solid top line, a dashed middle line, and a solid bottom line. The second set consists of a solid top line and a solid bottom line.

Handwriting practice lines for the letter 'n'. The first set consists of a solid top line, a dashed middle line, and a solid bottom line. The second set consists of a solid top line and a solid bottom line.

Handwriting practice lines for the letter 'n'. The first set consists of a solid top line, a dashed middle line, and a solid bottom line. The second set consists of a solid top line and a solid bottom line.

Handwriting practice lines for the letter 'n'. The first set consists of a solid top line, a dashed middle line, and a solid bottom line. The second set consists of a solid top line and a solid bottom line.

Handwriting practice lines for the letter 'n'. The first set consists of a solid top line, a dashed middle line, and a solid bottom line. The second set consists of a solid top line and a solid bottom line.

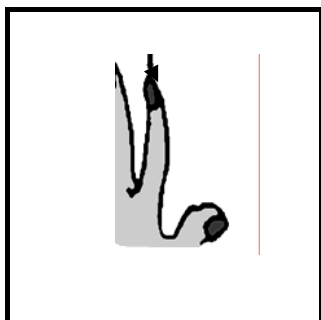

Handwriting practice lines for the letter 'n'. The first set consists of a solid top line, a dashed middle line, and a solid bottom line. The second set consists of a solid top line and a solid bottom line.

nei

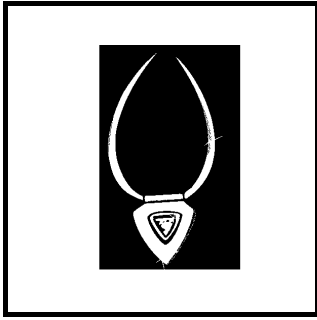
Petta er nisti  
Petta er nögl

Petta er nunna  
Petta er næla

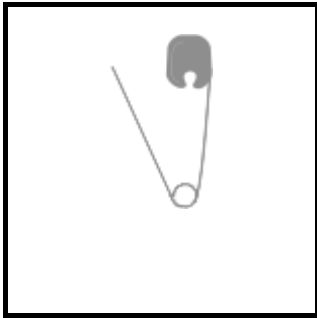
Petta er pabbi  
Petta er pera

Petta er nögl  
Petta er pylsa

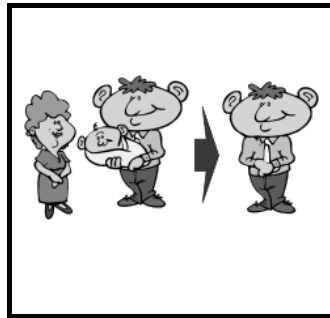

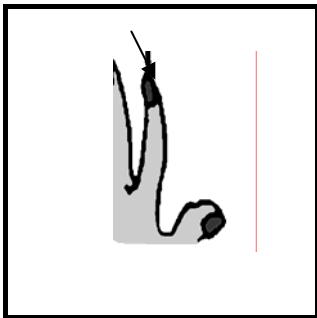
Petta er nunna  
Petta er poki

r            i e æ a y ö u o ei            R



rigning

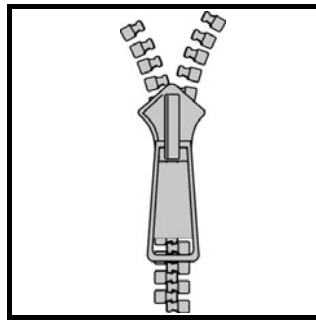

rennilás

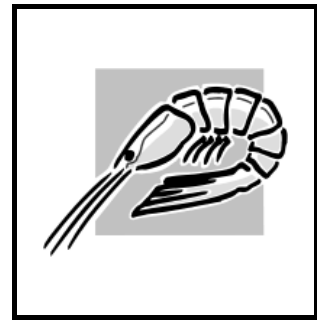

rækja



rakvél

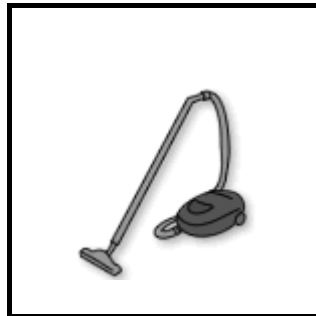

ryksuga

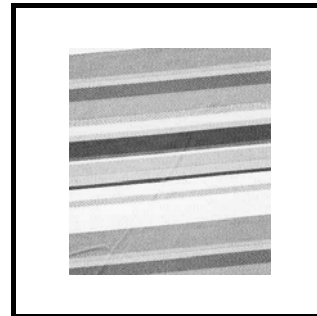

röndótt

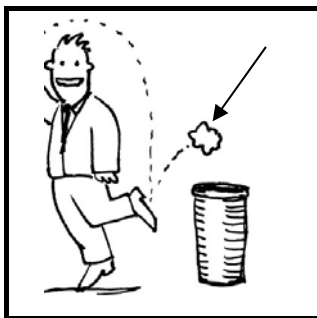

rusl

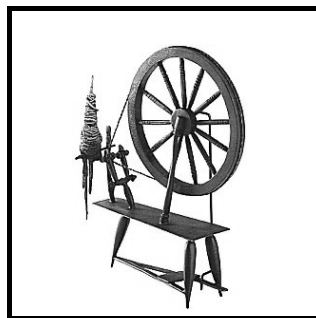

rokkur



reiður

-----  
-----  
-----  
-----  
-----  
-----  
-----

**s i e æ a y ö u o au S**

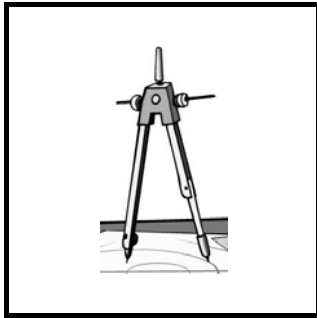

sirkill

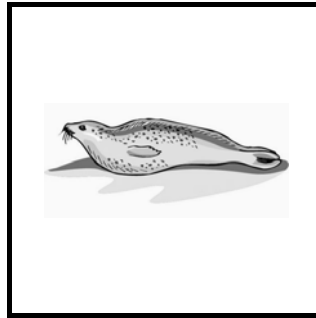

selur



sælgæti



sandali

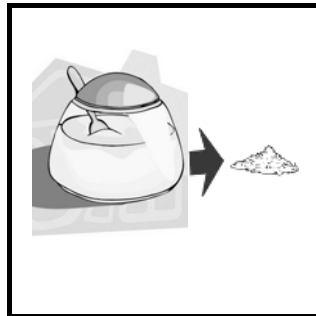

sykur

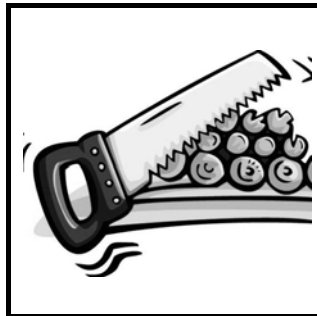

sög

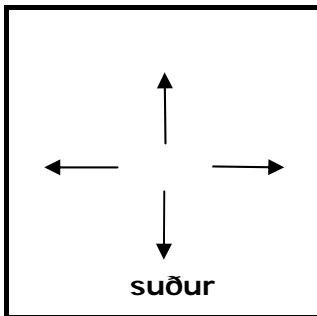

suður



sokkar

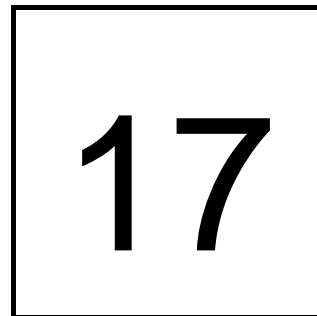

sautján

.....

.....

.....

.....

.....

.....

.....

.....



-----  
-----  
-----  
-----  
-----



-----  
-----  
-----  
-----  
-----



-----  
-----  
-----  
-----  
-----

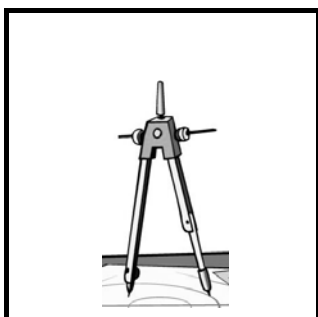

-----  
-----  
-----  
-----  
-----

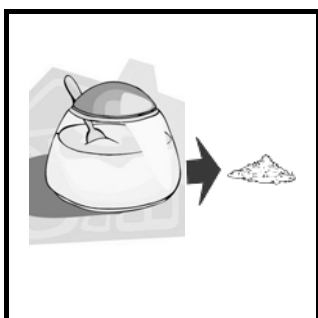

-----  
-----  
-----  
-----  
-----





- Þetta er sög
- Þetta er sælgæti

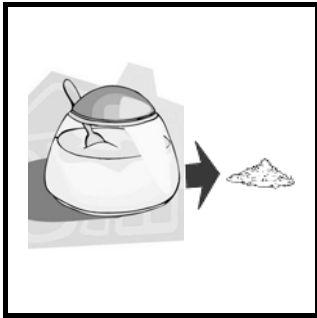

- Þetta er sykur
- Þetta er sirkill

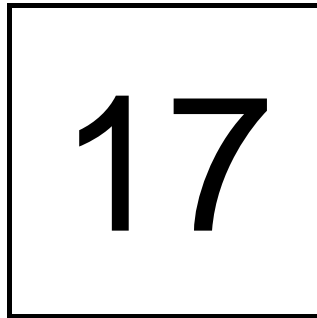

- Þetta er suður
- Þetta er sautján



- Þetta er selur
- Þetta er sandali

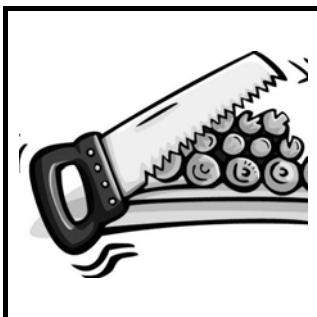

- Þetta er sög
- Þetta er sirkill

**t i e æ a y ö u o ei T**



tilraunaglas

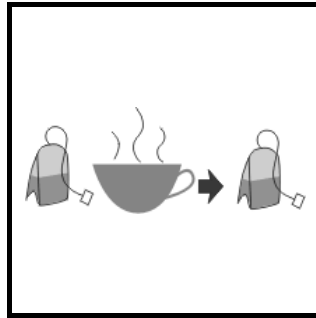

tepoki

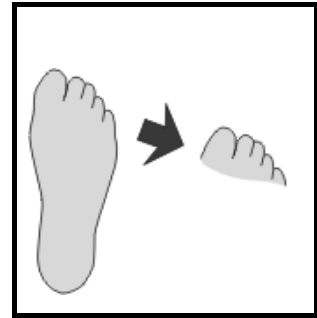

tær

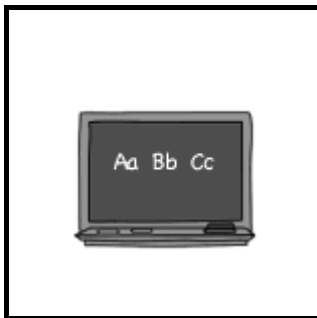

tafla



Tyrkland

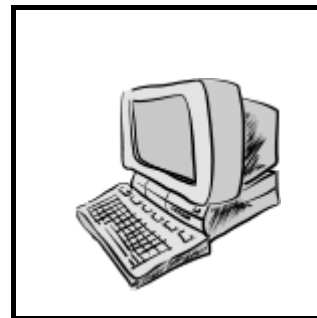

tölva

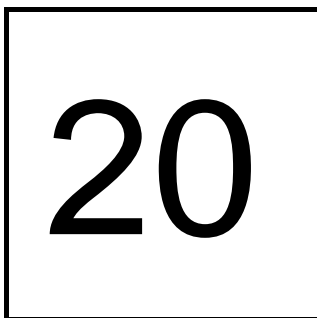

tuttugu



toppur



teikning

Handwriting practice lines consisting of four sets of horizontal lines (top, middle dashed, bottom) for writing practice.

**v** i e æ a y ö u o au **V**

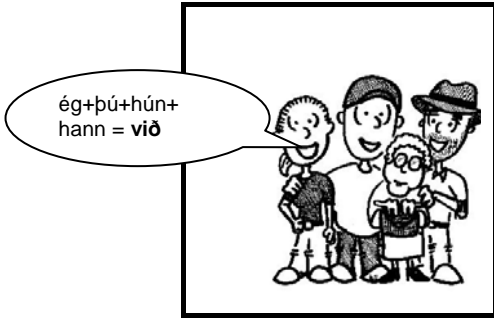

við

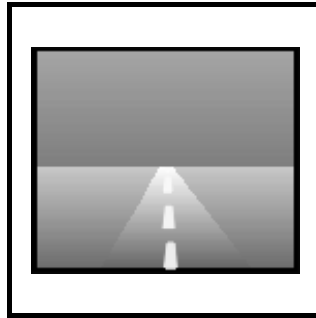

vegur

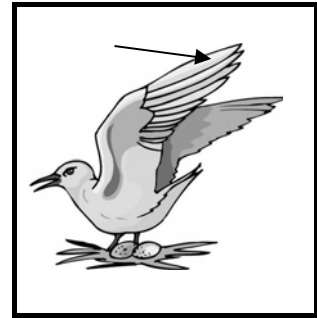

vængur

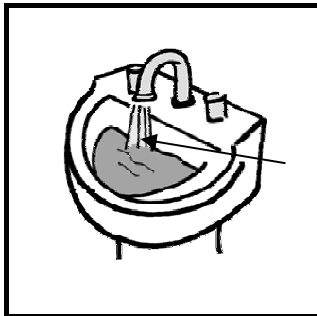

vatn

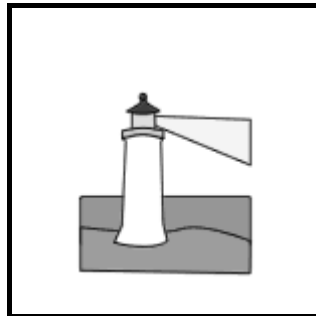

viti

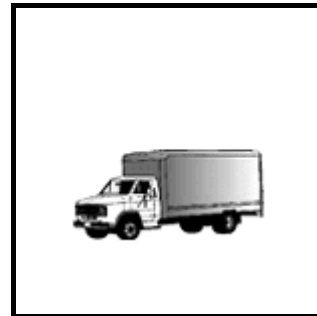

vörubíll



votviðri



verslun

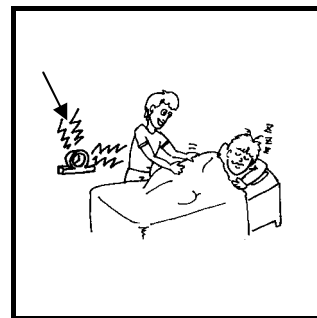

vekjari

.....

.....

.....

.....

.....

.....

.....

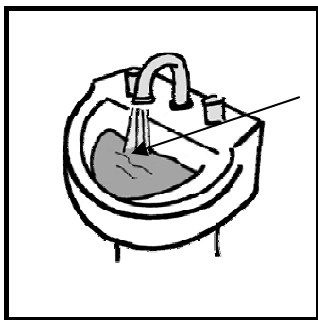
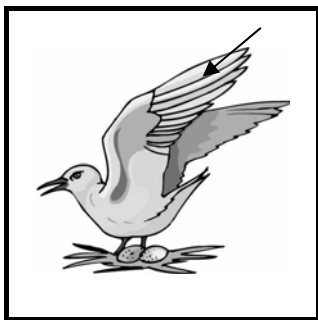
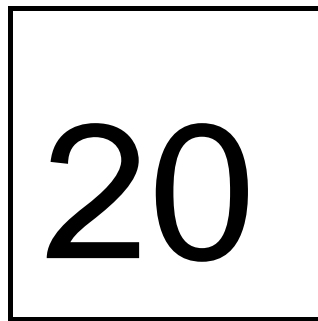
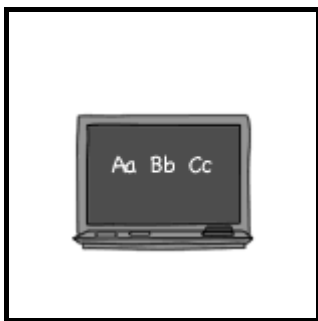
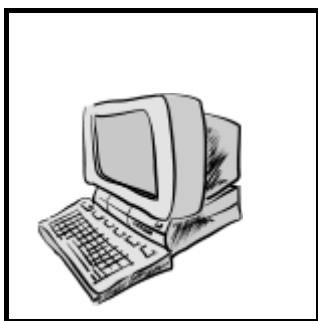

Handwriting practice lines consisting of a solid top line, a dashed middle line, and a solid bottom line. There are 20 such sets of lines, one for each illustration on the left.

20

- Petta er tuttugu
- Petta er tilraunaglas



- Petta er tafla
- Petta er toppur

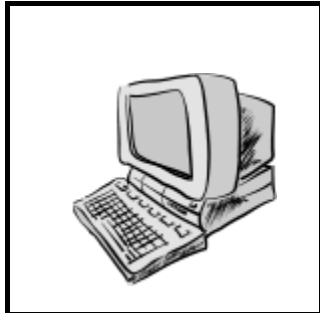

- Petta er tuttugu
- Petta er tölva

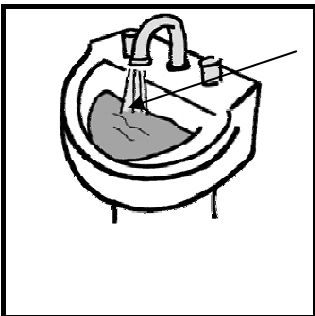

- Petta er vatn
- Petta er vekjari

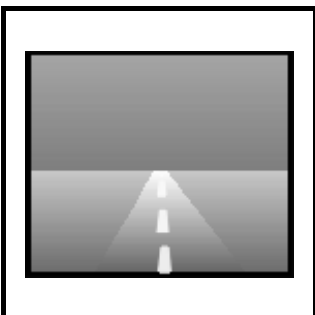

- Petta er vegur
- Petta er verslun

**þ**      **i e æ a y ö u o ey**      **Þ**

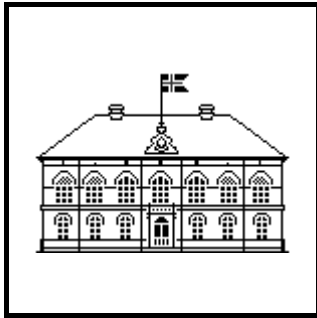

þinghús

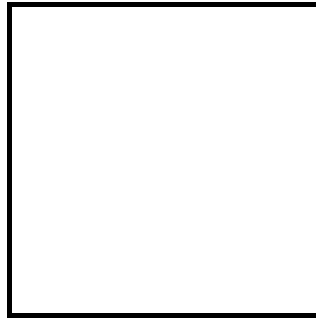

þefdýr

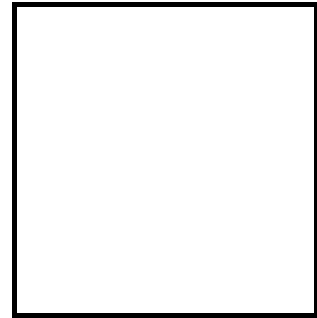

þær

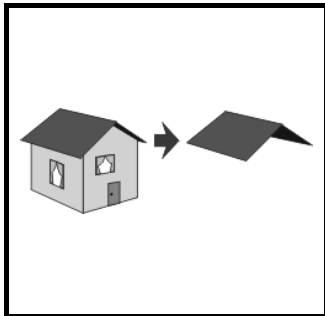

þak



þyrla

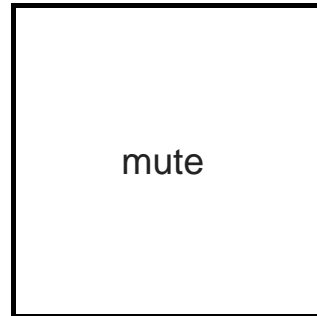

mute

þögn

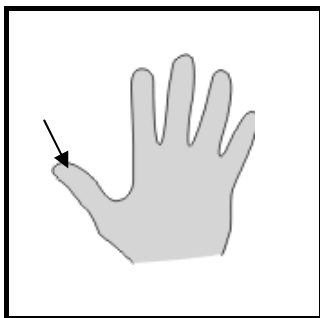

þumalfingur

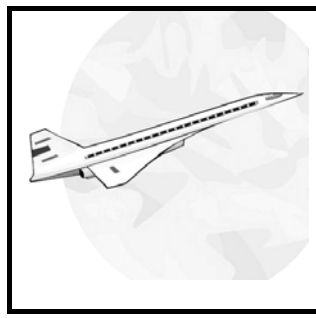

þota

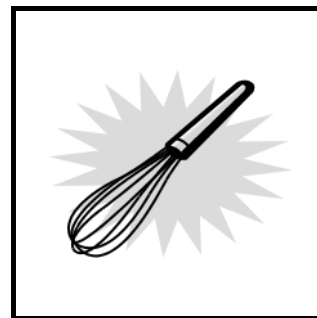

þeytari

-----  
-----  
-----  
-----  
-----  
-----  
-----  
-----



-----  
-----  
-----  
-----  
-----

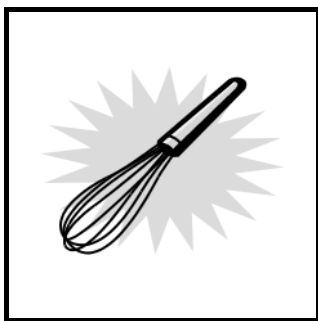

-----  
-----  
-----  
-----  
-----

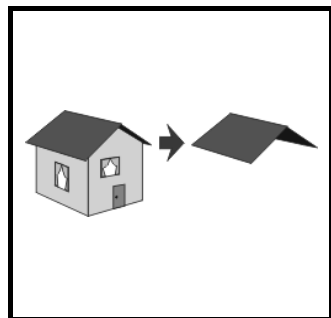

-----  
-----  
-----  
-----  
-----

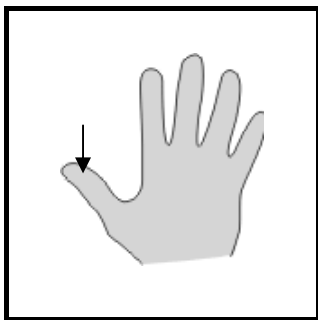

-----  
-----  
-----  
-----  
-----

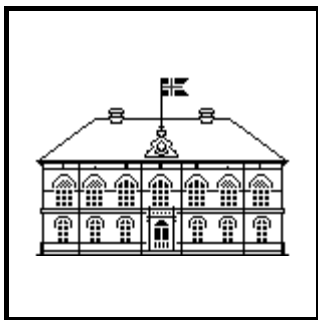

-----  
-----  
-----  
-----  
-----



- Þetta eru þær
- Þetta er þyrla

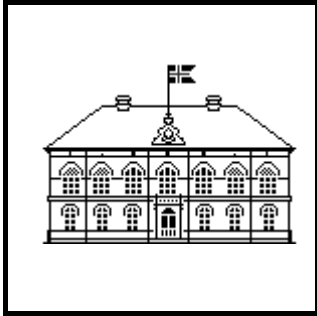

- Þetta er þumall
- Þetta er þinghús

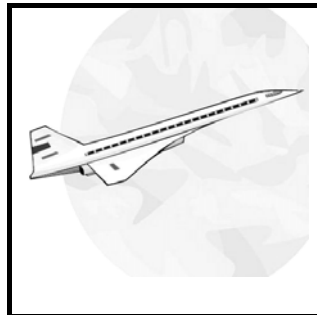

- Þetta er þögn
- Þetta er þota

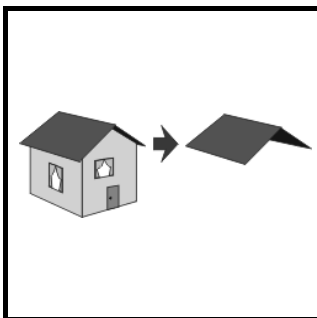

- Þetta er þefdyr
- Þetta er þak

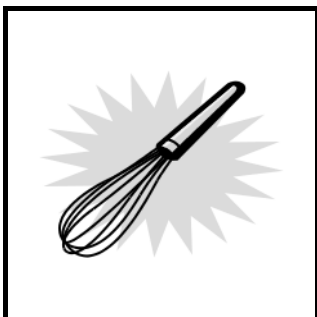

- Þetta er þeytari
- Þetta er þota



# Í é á ó ý ú



bíll



tré

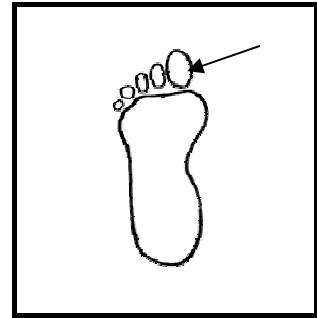

tá

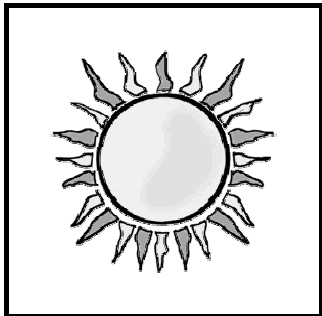

sól

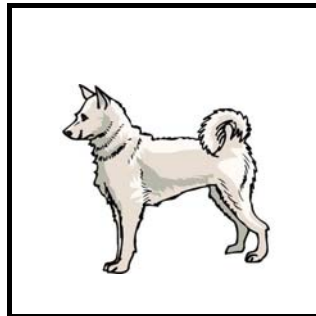

dýr



dúkka



hjól

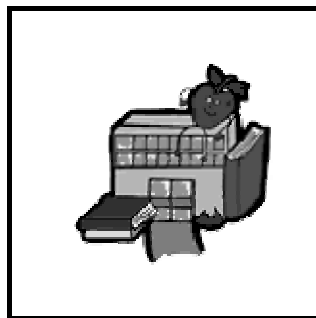

skóli



skór

-----  
-----  
-----  
-----  
-----  
-----  
-----

# í é á ó ý ú

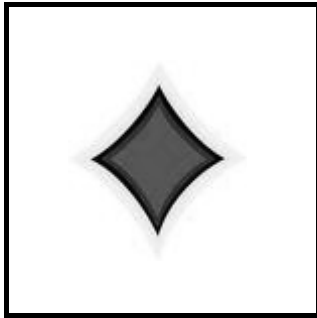

tígull

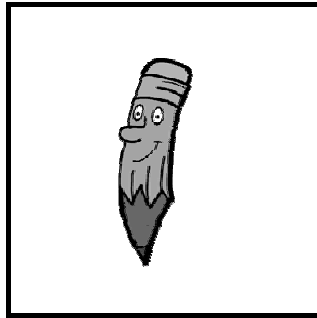

blýantur

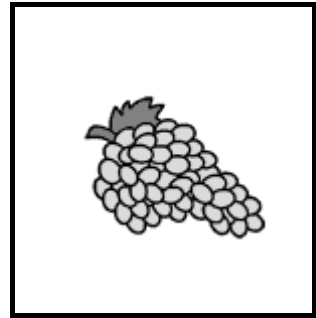

vínber

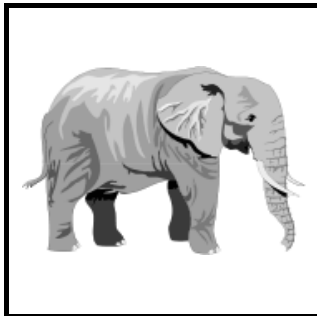

fíll

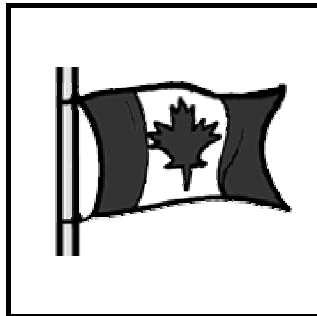

fáni

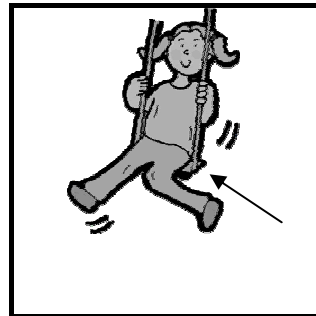

róla

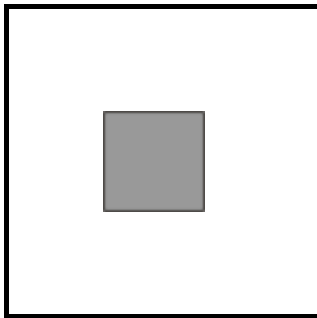

grár

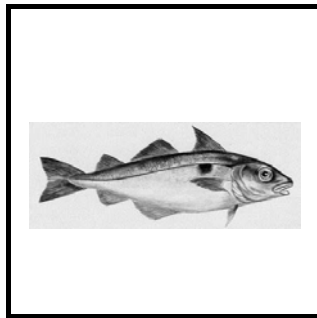

ýsa



sími

Handwriting practice lines consisting of four sets of three horizontal lines (top solid, middle dashed, bottom solid).

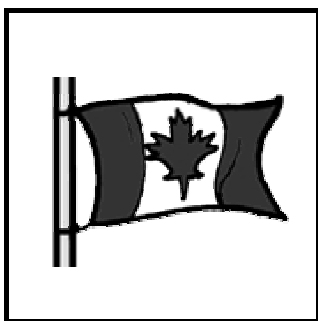

Four sets of handwriting practice lines, each consisting of a solid top line, a dashed middle line, and a solid bottom line.



Four sets of handwriting practice lines, each consisting of a solid top line, a dashed middle line, and a solid bottom line.

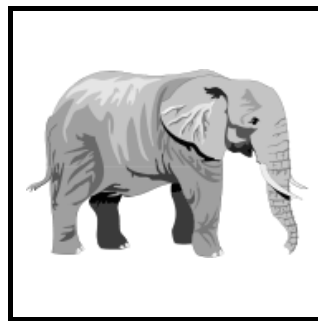

Four sets of handwriting practice lines, each consisting of a solid top line, a dashed middle line, and a solid bottom line.

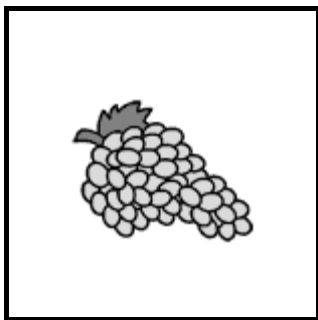

Four sets of handwriting practice lines, each consisting of a solid top line, a dashed middle line, and a solid bottom line.

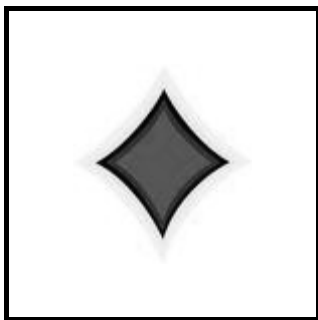

Four sets of handwriting practice lines, each consisting of a solid top line, a dashed middle line, and a solid bottom line.

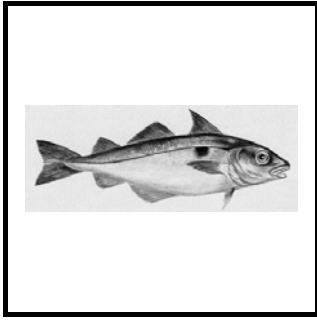

- Þetta er grár  
 Þetta er ýsa

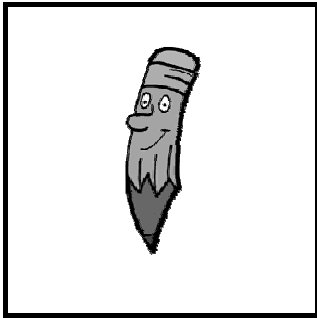

- Þetta er fáni  
 Þetta er blýantur

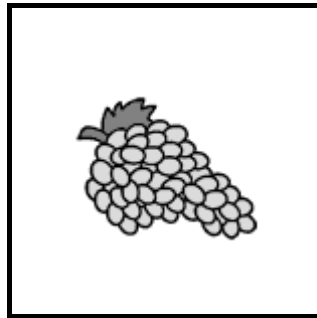

- Þetta eru vínber  
 Þetta er sími

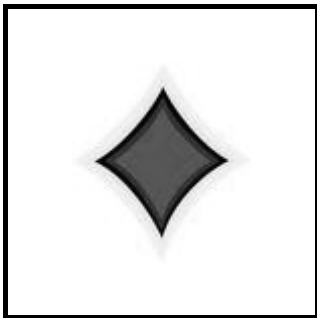

- Þetta er róla  
 Þetta er tígull

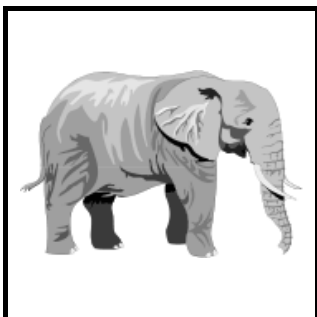

- Þetta er fíll  
 Þetta er sími

# í é á ó ý ú

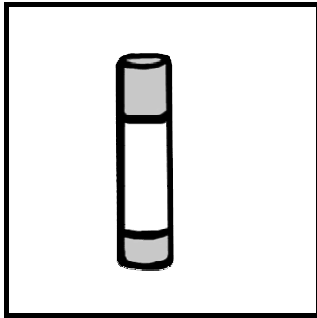

lím

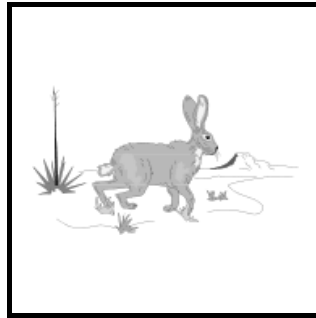

héri



kápa

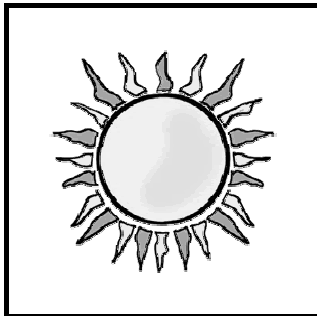

sól

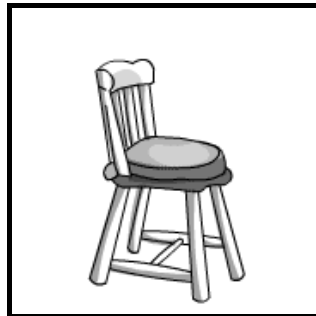

stóll

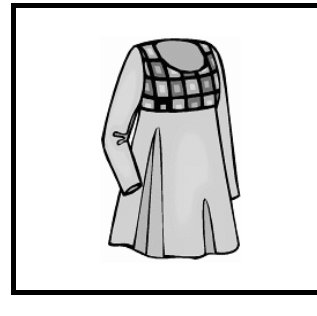

kjóll



ský



hús

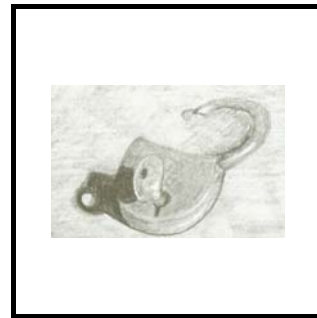

lás

-----  
-----  
-----  
-----  
-----  
-----  
-----

# í é á ó ý ú

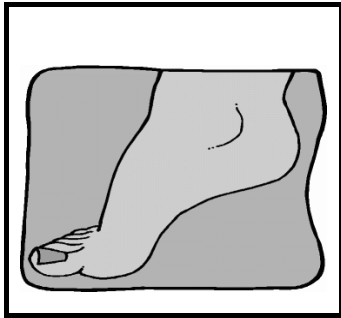

fótur



súpa

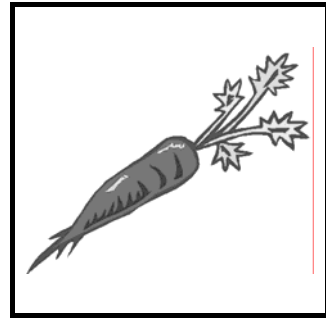

gulrót

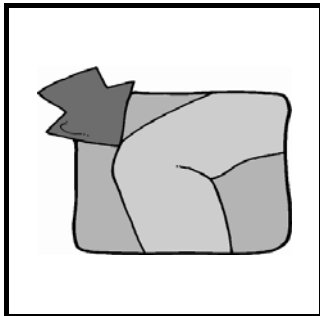

hné



bjór

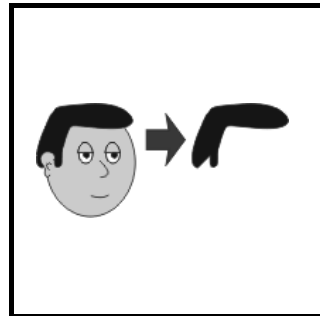

hár



rófa

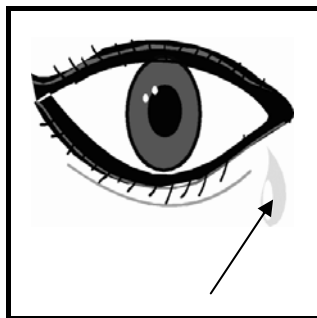

tár



blóm

Handwriting practice lines consisting of four sets of horizontal lines (top solid, middle dashed, bottom solid).

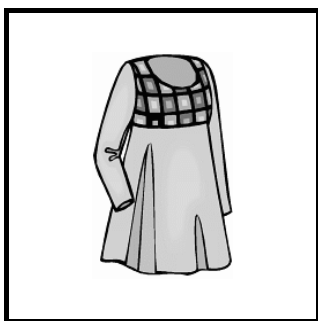

-----  
-----  
-----  
-----  
-----



-----  
-----  
-----  
-----  
-----



-----  
-----  
-----  
-----  
-----

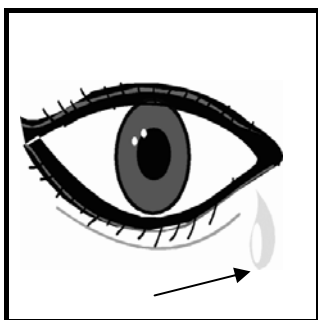

-----  
-----  
-----  
-----  
-----



-----  
-----  
-----  
-----  
-----

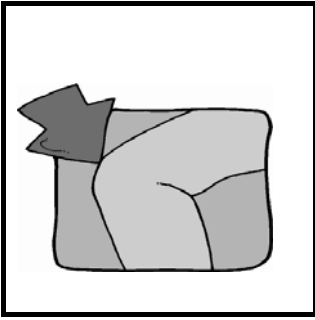

- Petta er hné
- Petta er hár

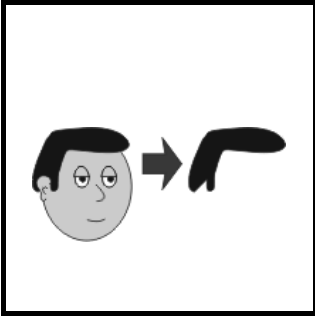

- Petta er bjór
- Petta er hár

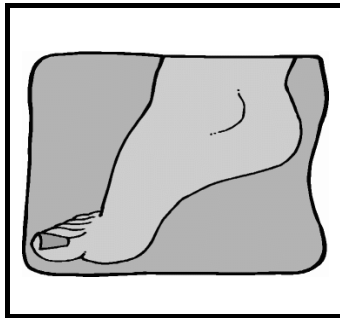

- Petta er hús
- Petta er fótur

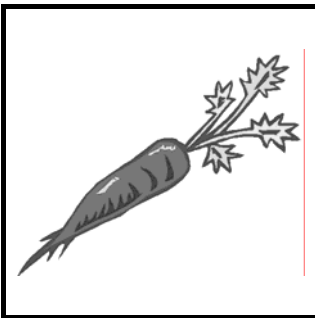

- Petta er gulrót
- Petta er tár

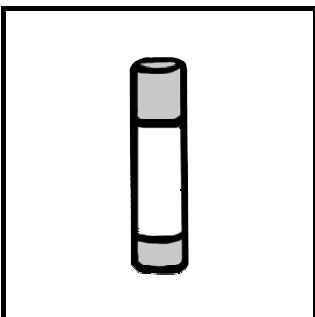

- Petta er kápa
- Petta er lím



# í é á ó ý ú

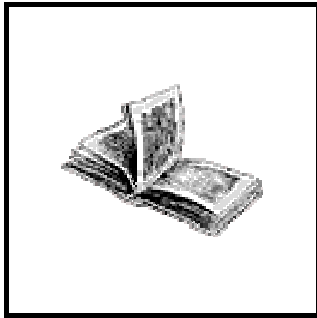

bók



kústur



grýla

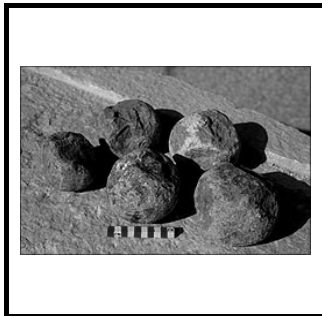

grjót

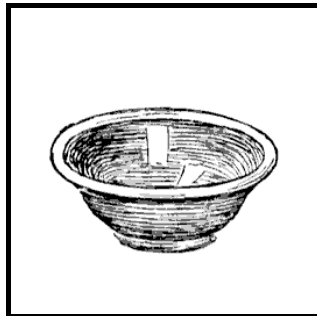

skál

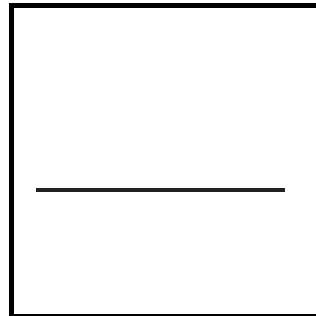

lína



trúður



pálmi

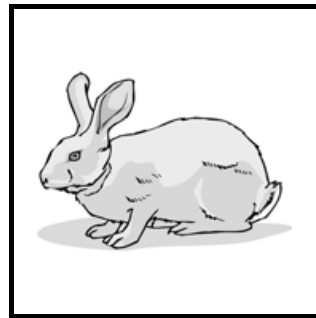

kanína

-----  
-----  
-----  
-----  
-----  
-----

# í é á ó ý ú

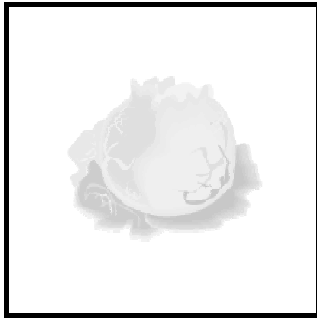

kál

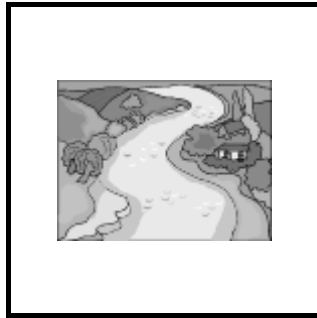

á

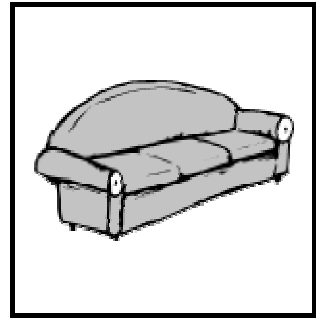

sófi



rós

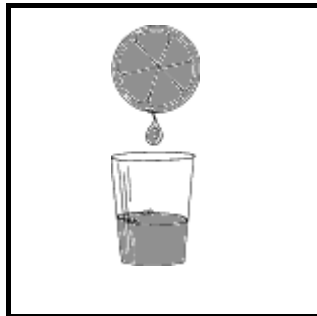

djús

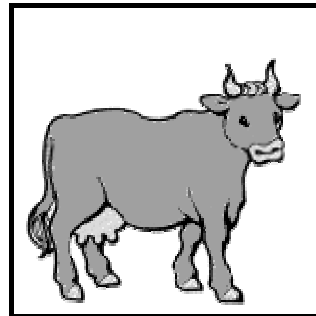

kýr

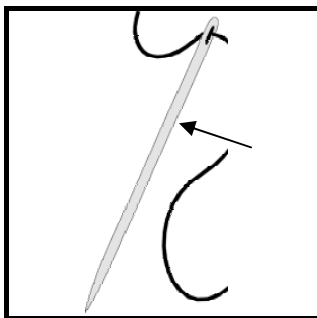

nál

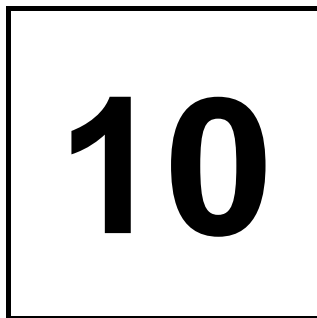

tíu

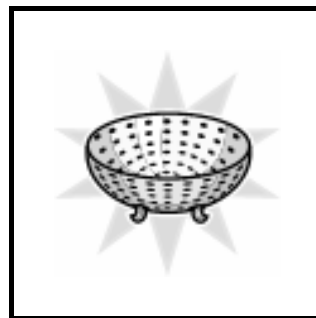

sía

Handwriting practice lines consisting of four sets of horizontal lines, each set with a solid top line, a dashed middle line, and a solid bottom line.



-----  
-----  
-----  
-----  
-----



-----  
-----  
-----  
-----  
-----

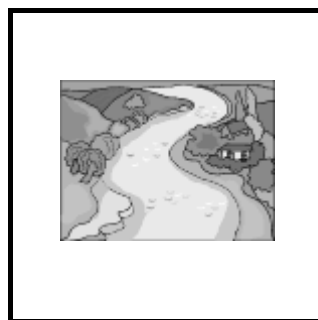

-----  
-----  
-----  
-----  
-----



-----  
-----  
-----  
-----  
-----

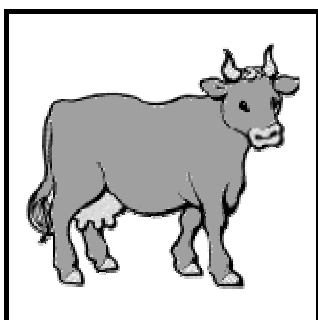

-----  
-----  
-----  
-----  
-----



- Petta er grjót
- Petta er bók



- Petta er kanína
- Petta er rós

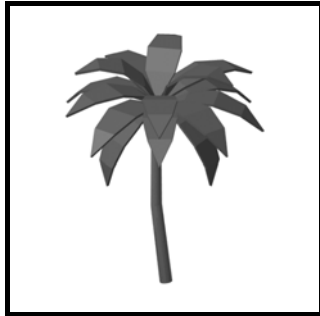

- Petta er tíu
- Petta er pálmi

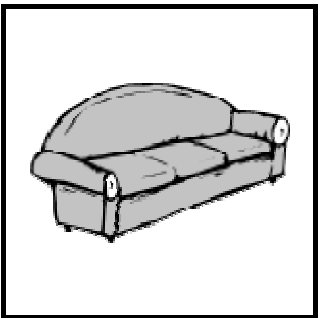

- Petta er nál
- Petta er sófi

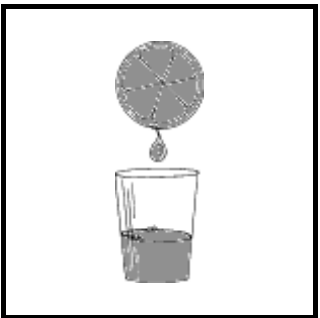

- Petta er djús
- Petta er rós

X

X



buxur



lax



mixari

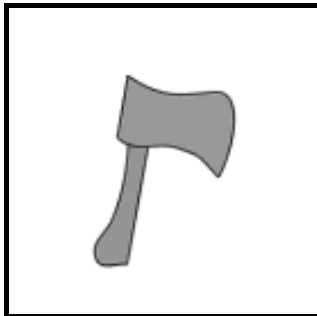

öxi

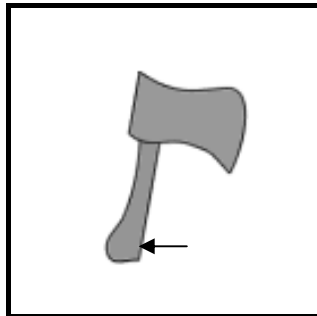

axarskaft



Axel

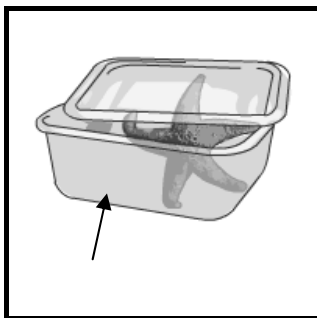

box



kex



fax

-----  
-----  
-----  
-----  
-----  
-----  
-----  
-----



- Þetta er lax
- Þetta er mixari

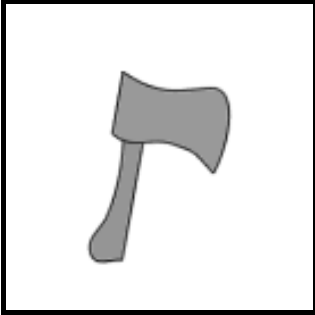

- Þetta er öxi
- Þetta er box

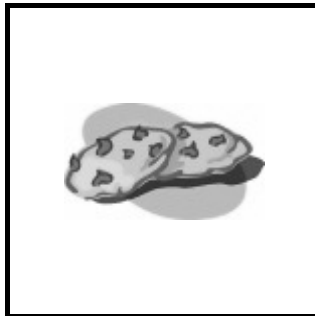

- Þetta er öxi
- Þetta er kex



- Þetta er axarskaft
- Þetta er fax

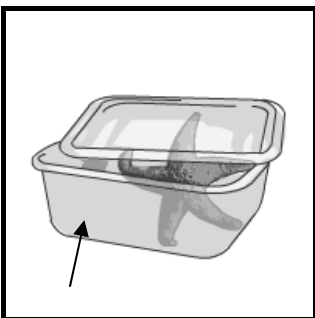

- Þetta eru buxur
- Þetta er box