

Eldhús og eldhúsahöld

Skrifaðu rétt orð á réttan stað. Notaðu orðin í orðakassanum.

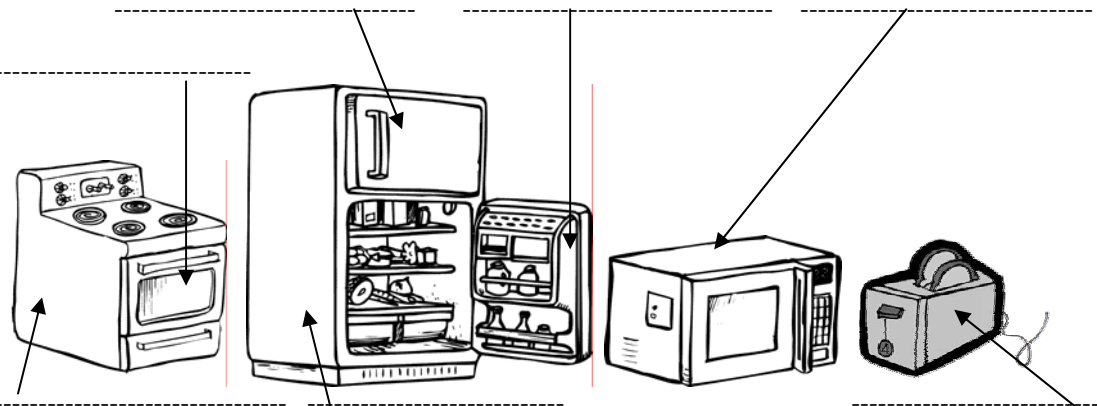
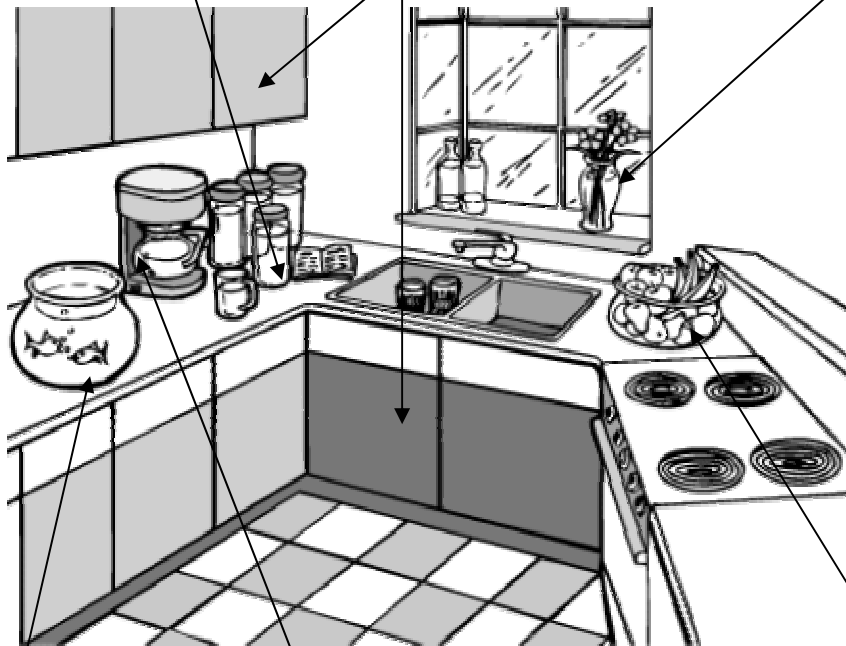

eldhús	ávextir í skál	eldavél	ofn
kaffikanna	frystihólf	brauðrist	ísskápur
ketill	örbylgjuofn	eldhússkápar	eldhúsruilla
krukka	fiskabúr	blóm í vasa	ísskáphurð

Eldhús og eldhúsahöld

Skrifaðu rétt orð á réttan stað. Notaðu orðin í orðakassanum.

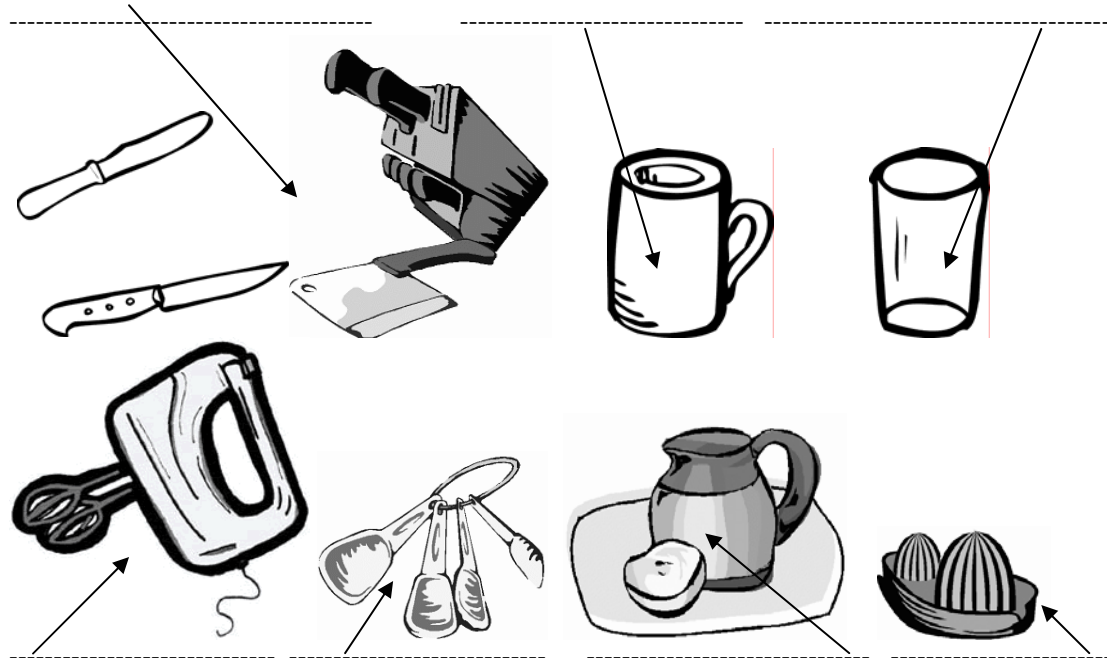
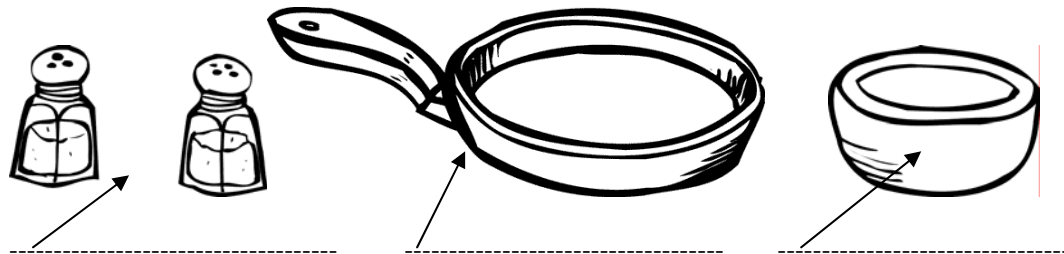
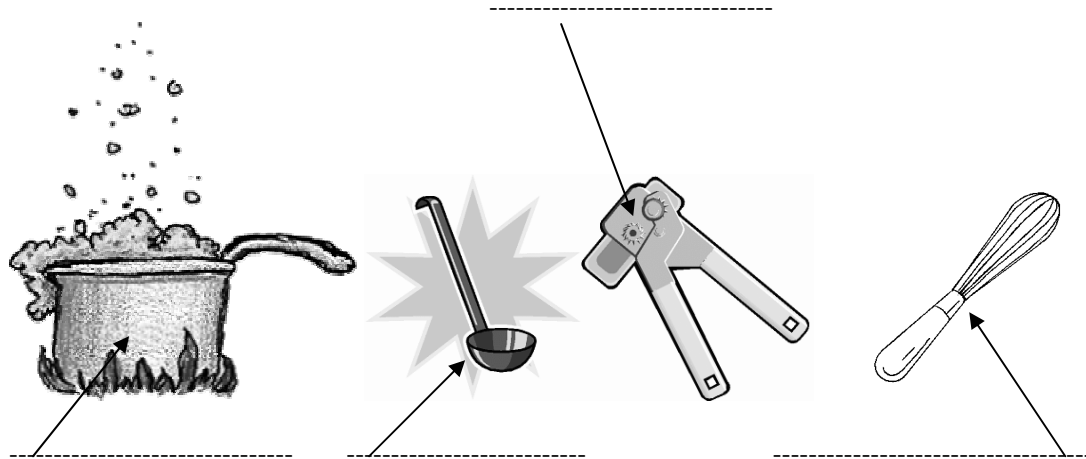

salt og pipar glas dósaopnari hrærivél	skál mæliskeiðar þeytari mjólkurkanna	hnífar drykkjarkrús ávaxtapressa pottur	ausa panna
---	--	--	---------------

Eldhús og eldhúsáhöld

Skrifaðu rétt orð á réttan stað. Notaðu orðin í orðakassanum.

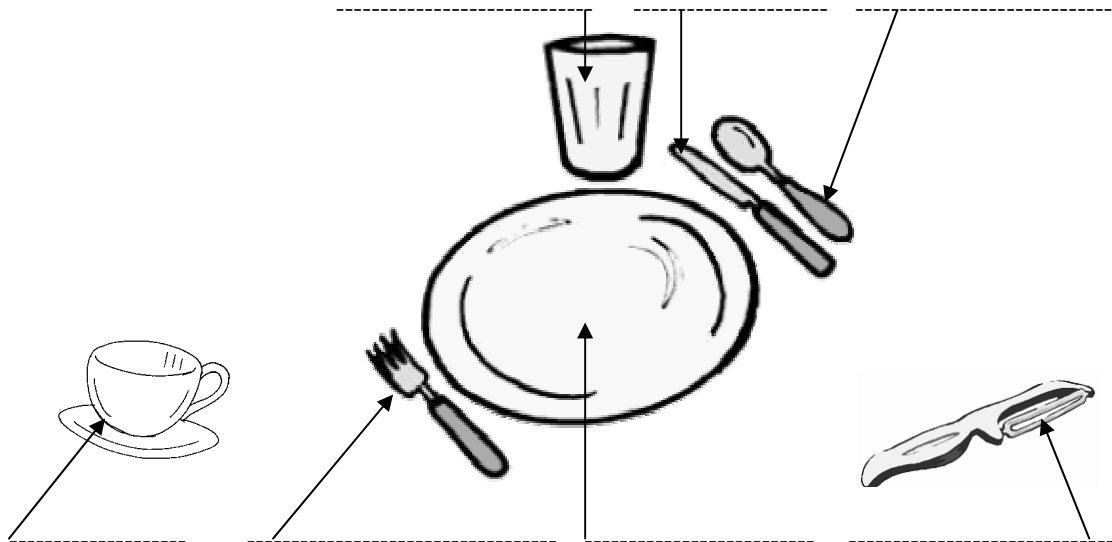
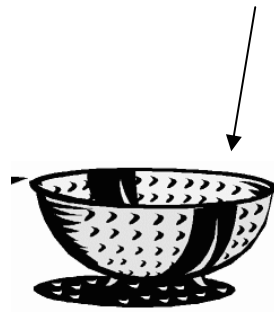
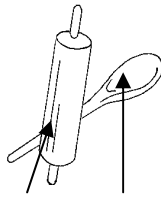
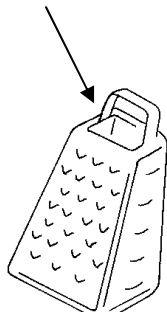
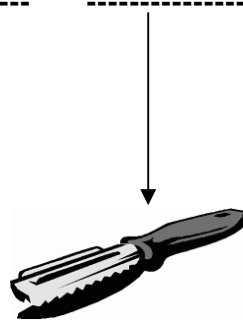

blandari	diskur	sigti	skeið
sleif	hnífur	eplaskeri	rifjárn
skrælari	glas	vigt	
gaffall	kökukefli	bolli	

Eldhús og eldhúsahöld

Skrifaðu rétt orð á réttan stað. Notaðu orðin í orðakassanum.

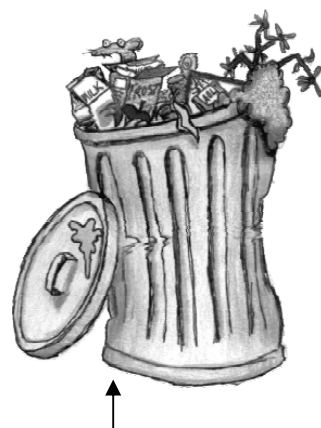
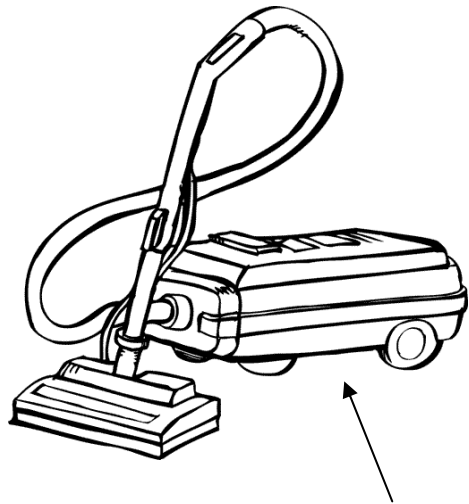
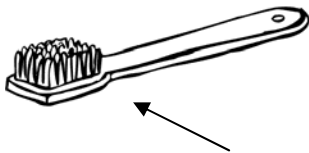
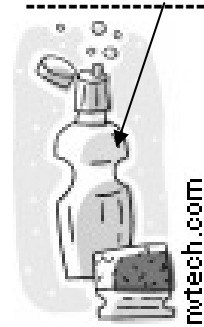
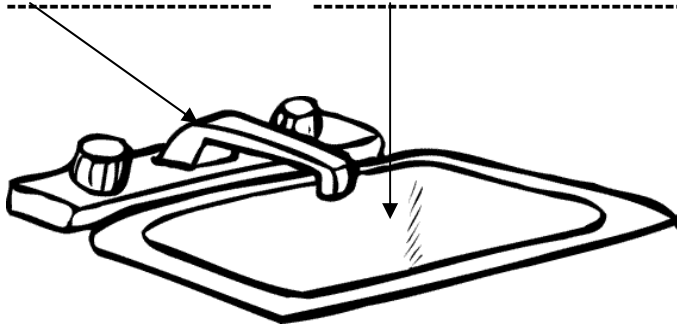

kústur	fægiskúffa
ruslatunna	uppvottabursti
ryksuga	eldhúsvaskur
uppvottalög	krani

Kitchen supplies

-----jar-----

---kitchen cabinet-----

---flowers in a vase---

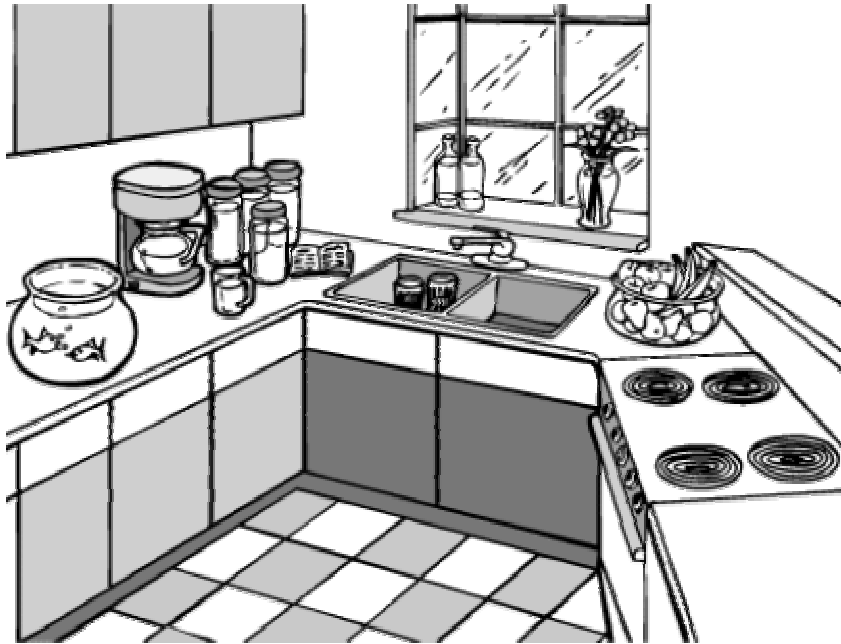

--fruits in a bowl--

-----aquarium-----

-----coffemaker-----

---freezer---

---refrigerator door---

-----microwave oven-----

---oven---

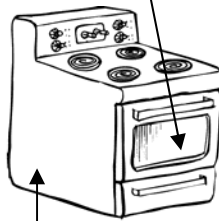

---stove---

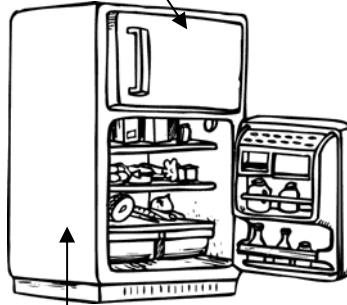

-----refrigerator-----

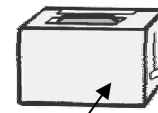
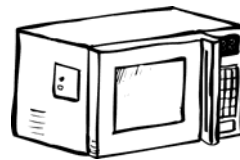

---toaster---



--papertowel--



--teapot--

Kitchen supplies

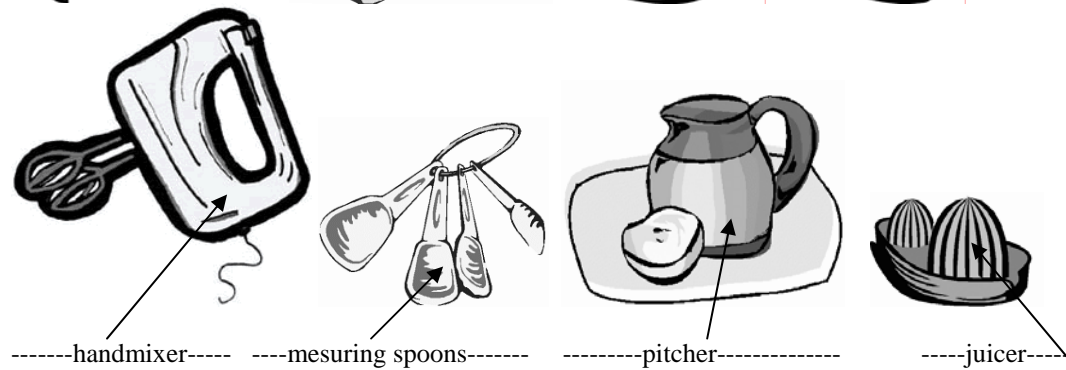
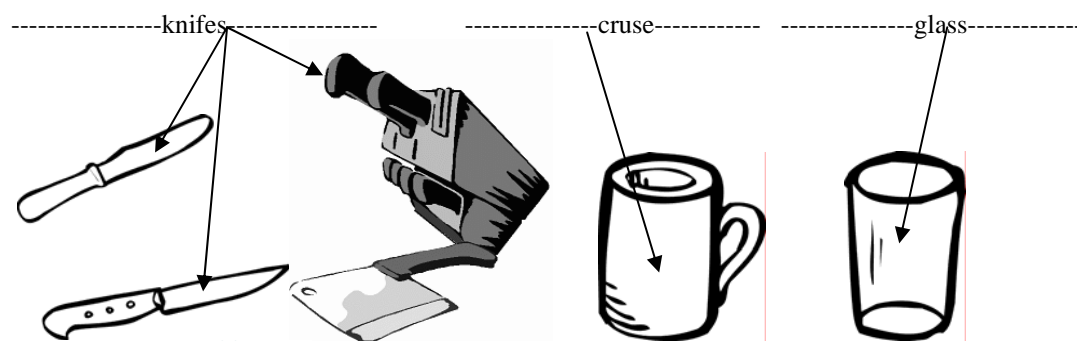
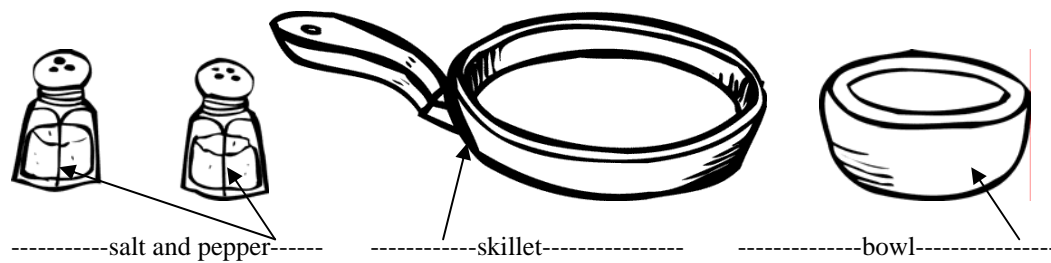
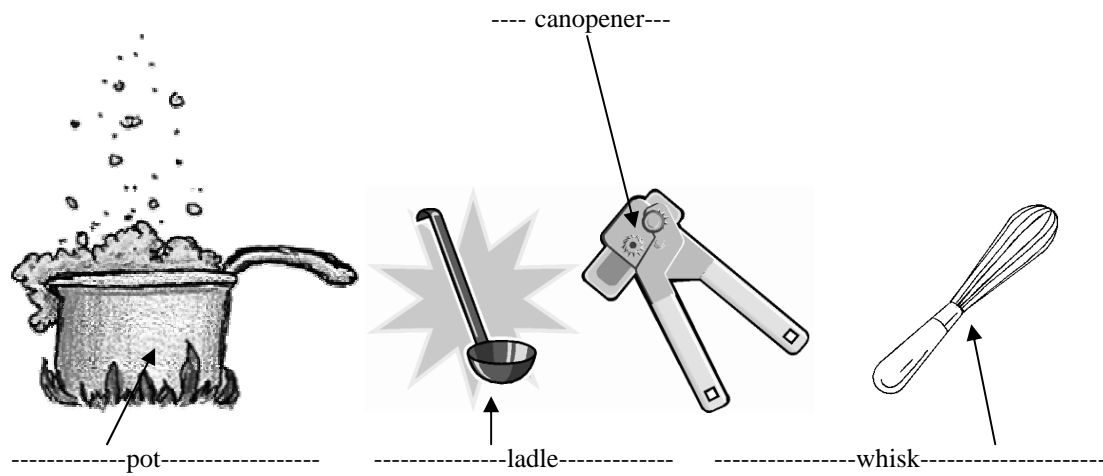

Kitchen supplies

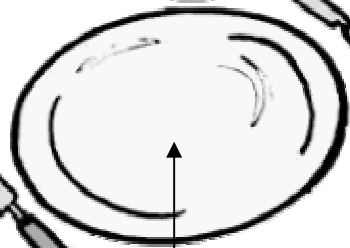
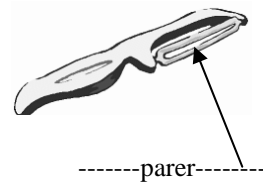
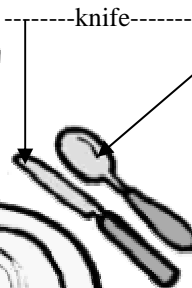
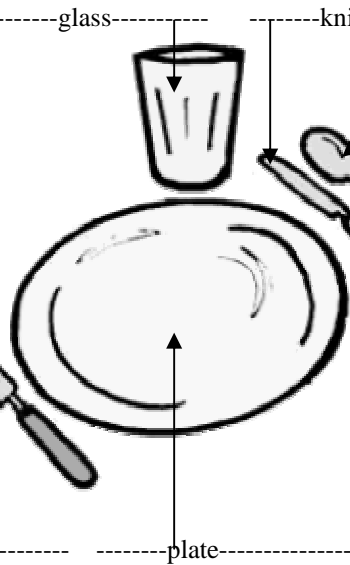
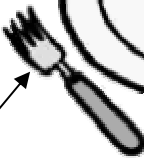
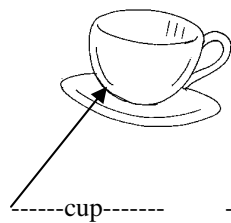
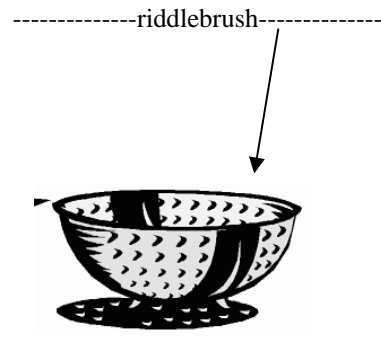
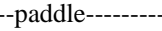
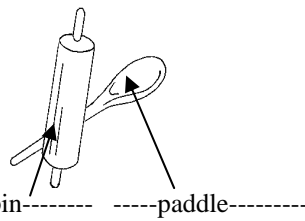
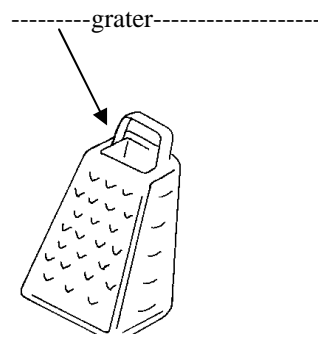
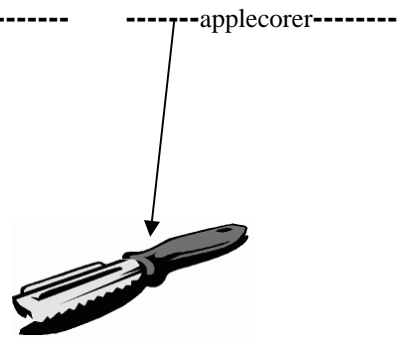
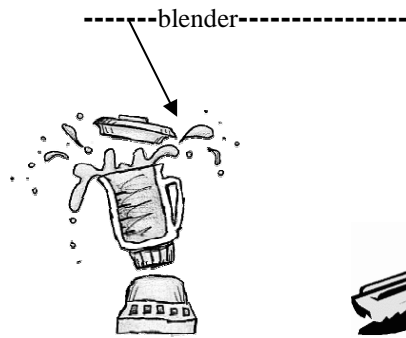
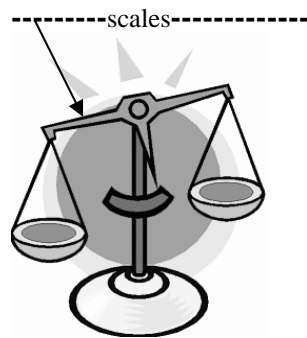

Kitchen supplies

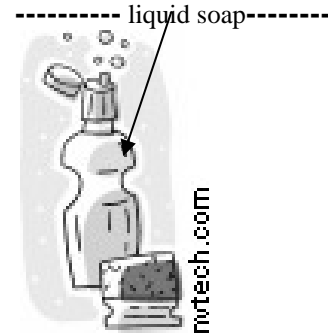
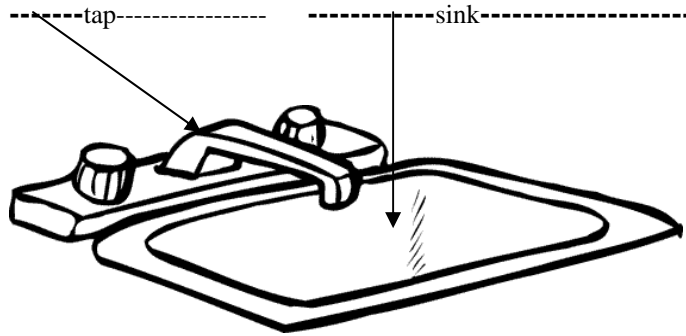

-----washing up brush-----

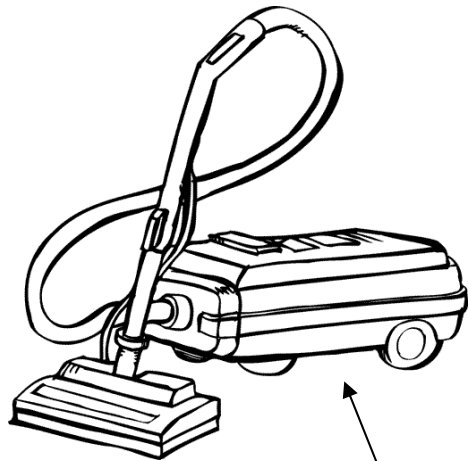

-----vacuum cleaner-----



-----sweeper-----

-----dustpan-----



-----trash can-----